

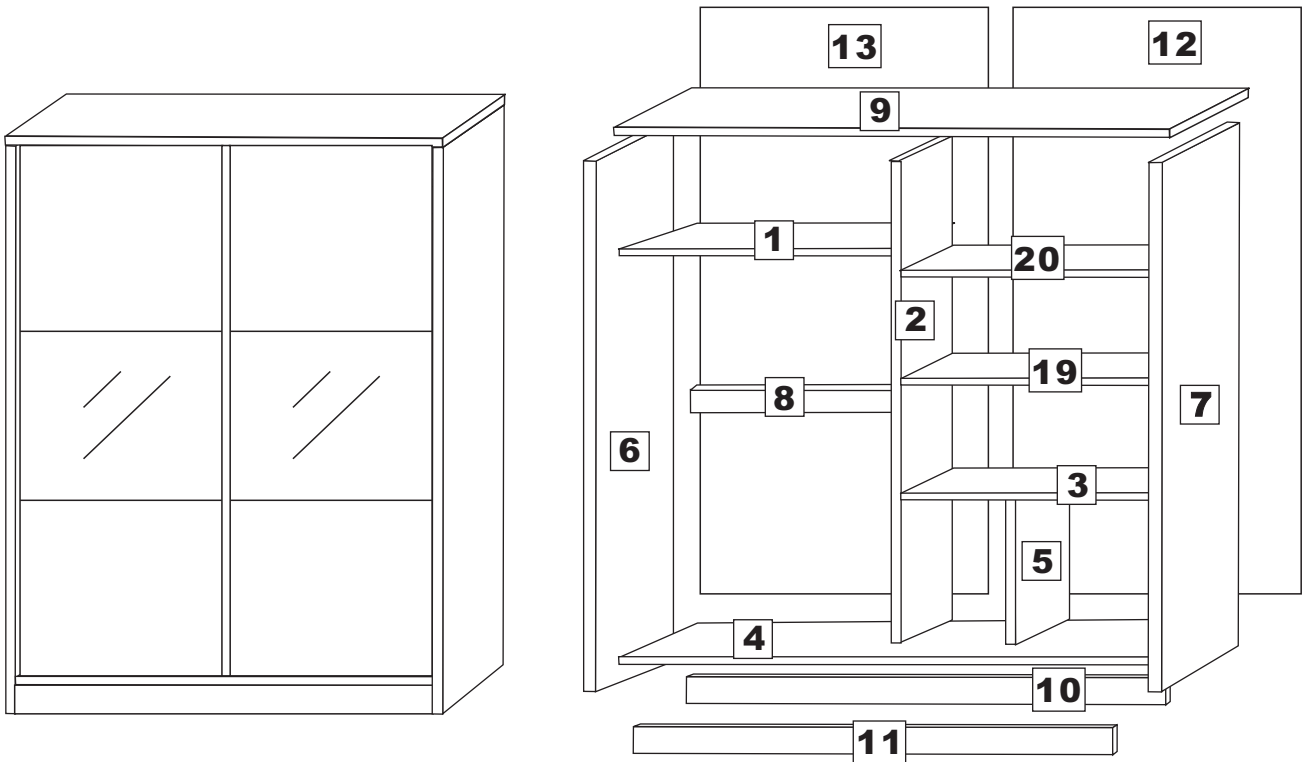













# 249-000019

## ASSEMBLY INSTRUCTIONS

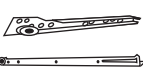
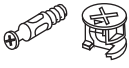
Please Keep For Future Reference

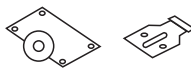

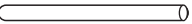
### HARDWARE

<p>(A)</p>  <p>JCBC M6 X 40mm X 28</p>	<p>(B)</p>  <p>M4 X 32mm X 18</p>	<p>(C)</p>  <p>M3.5 X 14mm X 98</p>	<p>(D)</p>  <p>Nail X 90</p>
<p>(E)</p>  <p>Leg X 4</p>	<p>(F)</p>  <p>Leg X 2</p>	<p>(G)</p>  <p>Handle X 3</p>	<p>(H)</p>  <p>Dowel 8 x 25mm X 8</p>
<p>(I)</p>  <p>Drawer Slide 14" X 3 Sets</p>	<p>(J)</p>  <p>Mini Fit X 6 Sets</p>	<p>(K)</p>  <p>Shelf Support X 8</p>	<p>(L)</p>  <p>Sliding Rail X 2</p>
<p>(M)</p>  <p>Sliding Wheel X 4 Sets</p>	<p>(N)</p>  <p>L-Bracket X 2</p>	<p>(O)</p>  <p>Pipe X 2</p>	<p>(P)</p>  <p>Allen Key X 1</p>

Ruler- Use this ruler to help correctly identify the bolts.

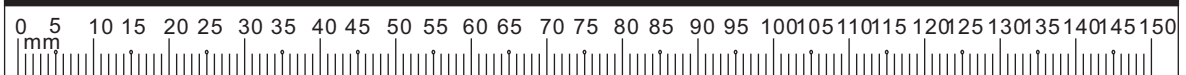

STEP 1

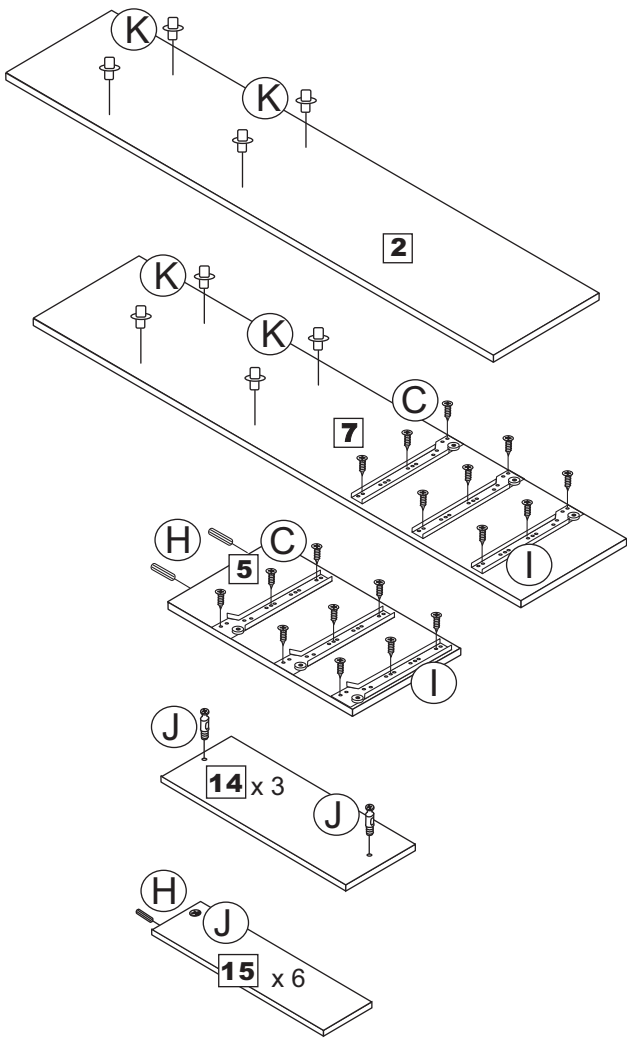

STEP 2

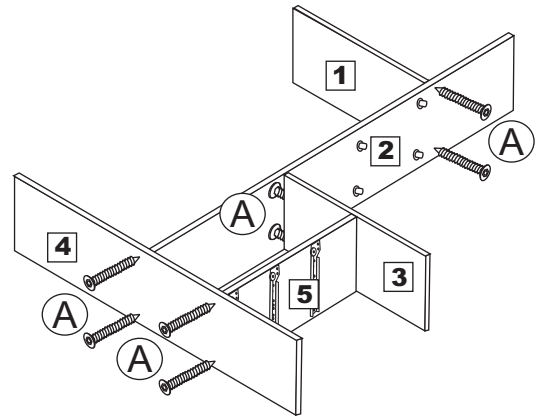

STEP 3

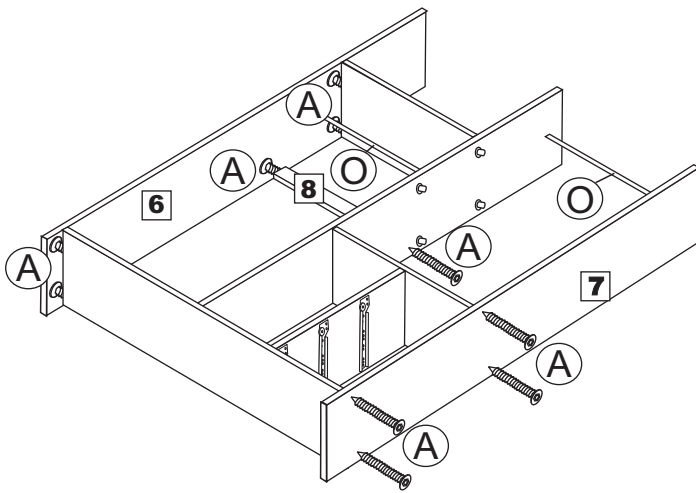

STEP 4

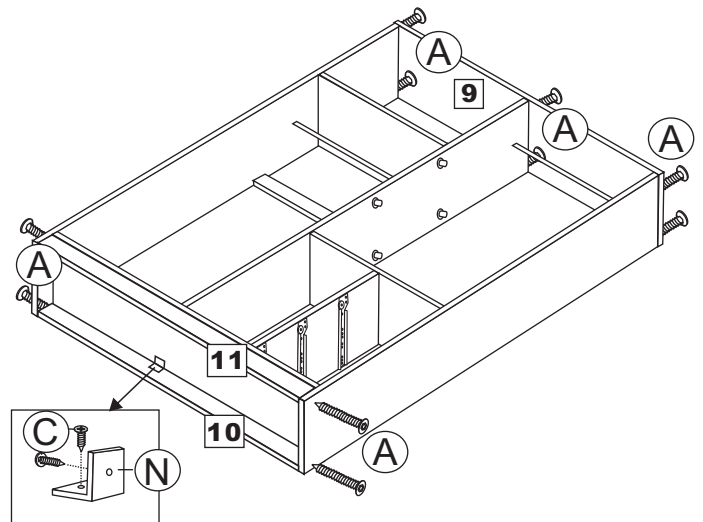

STEP 5

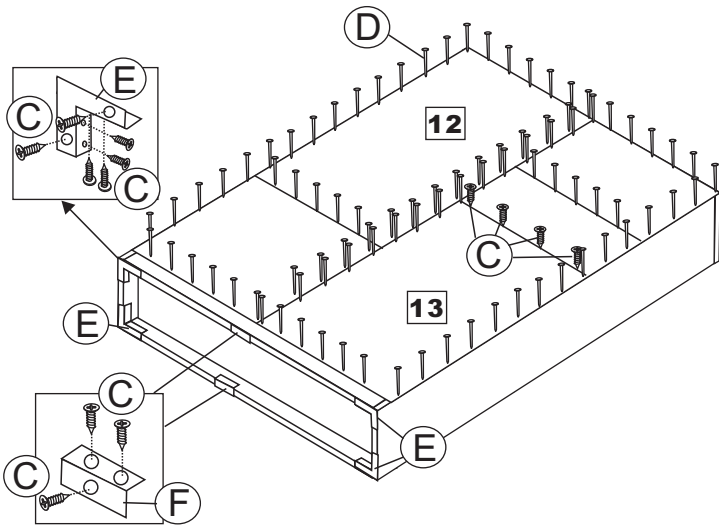

STEP 6

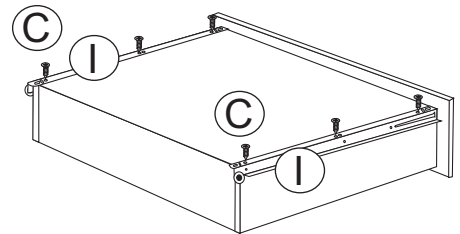
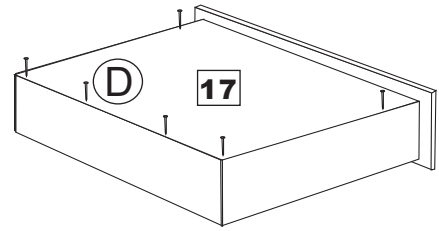
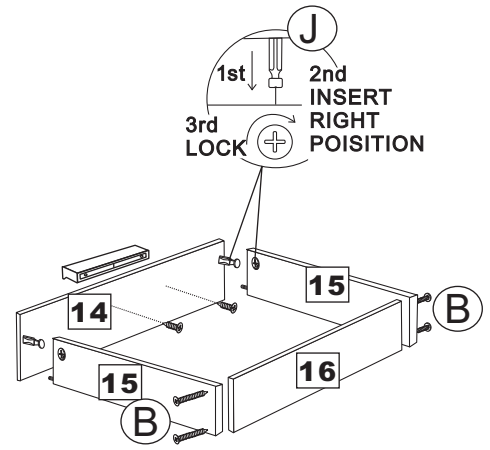

X 3 SETS

STEP 7

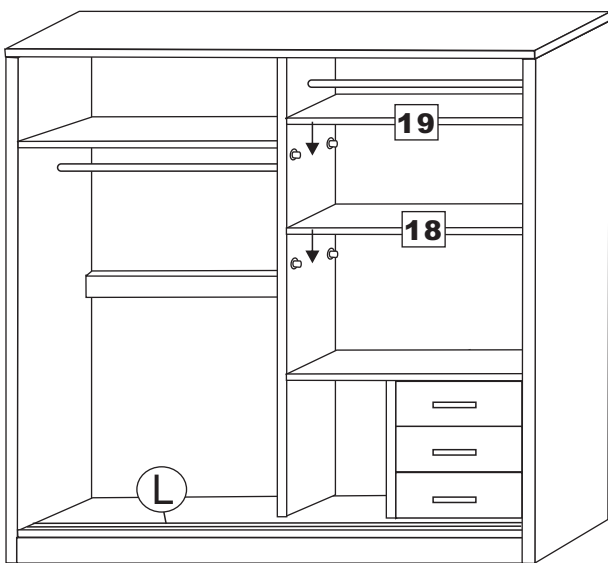

STEP 8

