

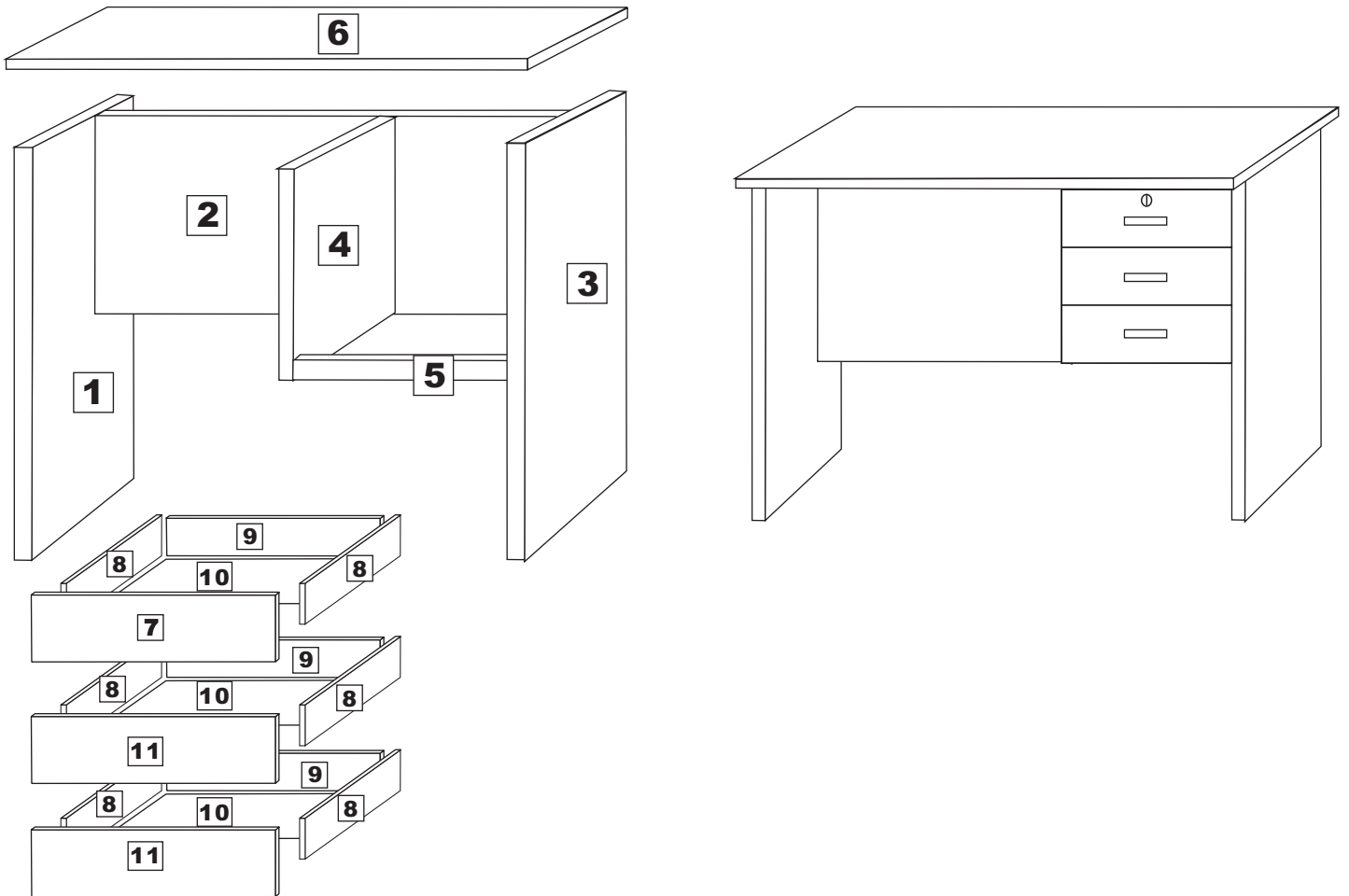











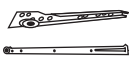

# PRODUCT CODE : 249-000011

## ASSEMBLY INSTRUCTIONS

Please Keep For Future Reference



HARDWARE							
<b>(A)</b>  JCBC M6 X 40mm X 8	<b>(B)</b>  M4 X 32mm X 18	<b>(C)</b>  Allen Key X 1	<b>(D)</b>  M3.5 X 20mm X 4	<b>(E)</b>  M3.5 X 14mm X 42	<b>(F)</b>  Nail X 18	<b>(G)</b>  Dowel (M8X25) X 5	<b>(H)</b>  Dowel (M6X25) X 6
<b>(I)</b>  Drawer Slide X 3 sets	<b>(J)</b>  Mini Fit X 6 sets	<b>(K)</b>  L-Bracket X 5	<b>(L)</b>  Handle X 3	<b>(M)</b>  Leg Pin X 4	<b>(N)</b>  Cam Lock X 1	<b>(O)</b>  Lock Stopper X 1	

Ruler- Use this ruler to help correctly identify the bolts.



STEP 1

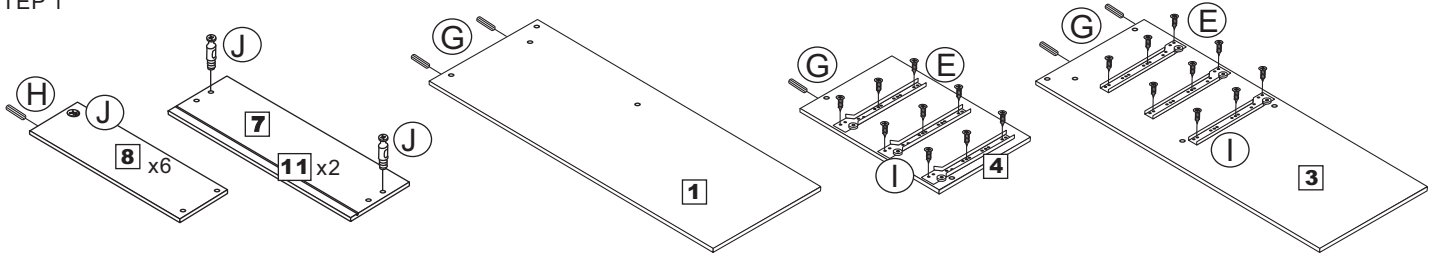

STEP 2

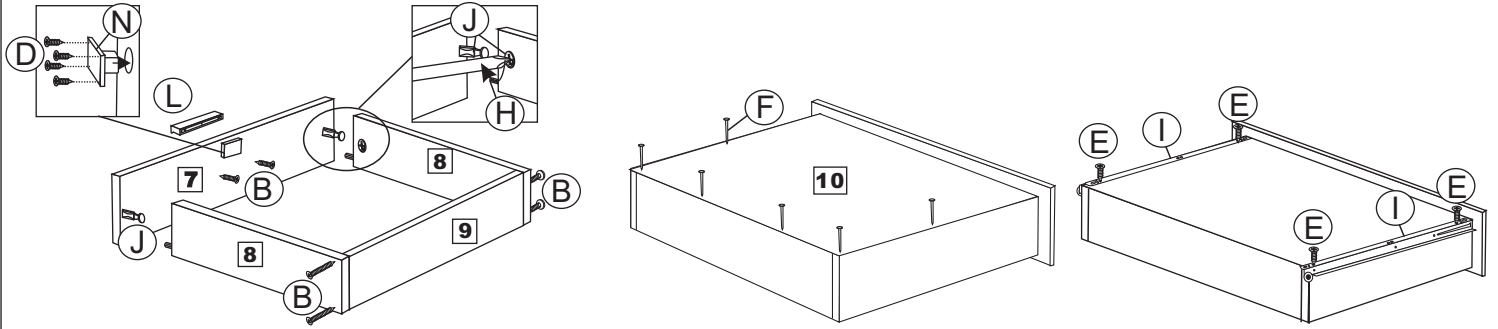

STEP 3

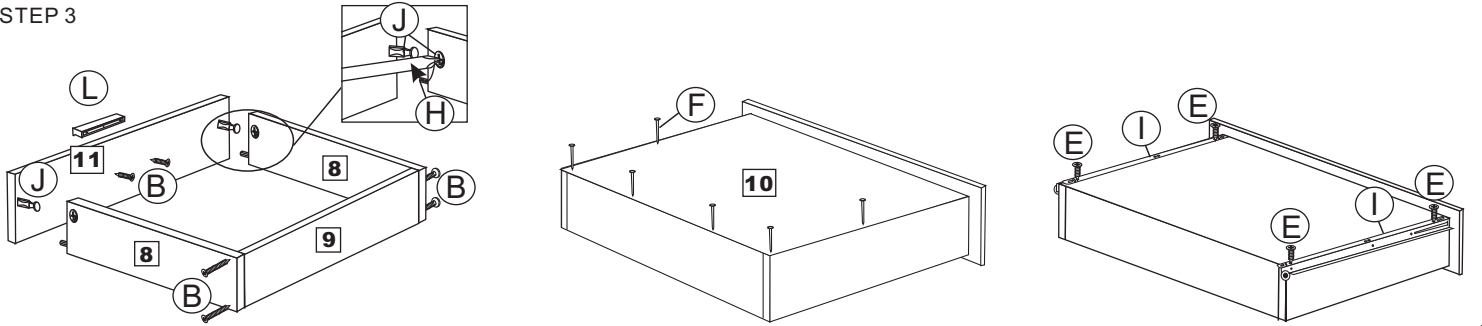

STEP 4

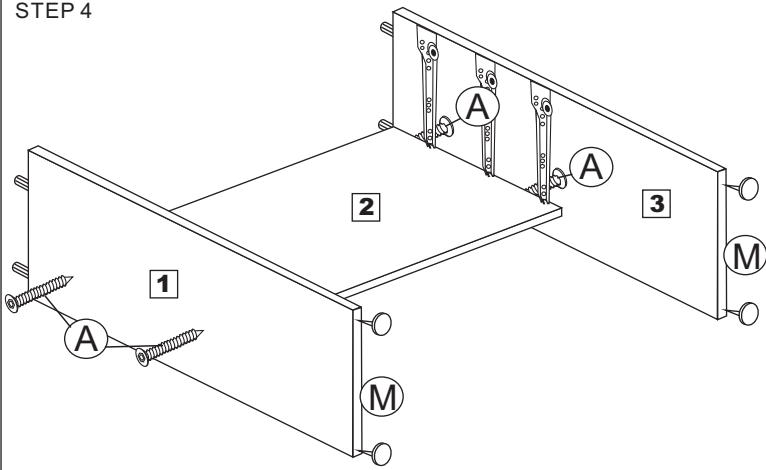

STEP 5

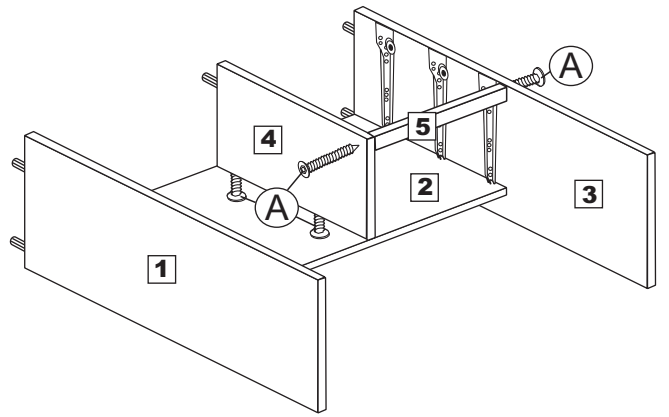

STEP 6

