

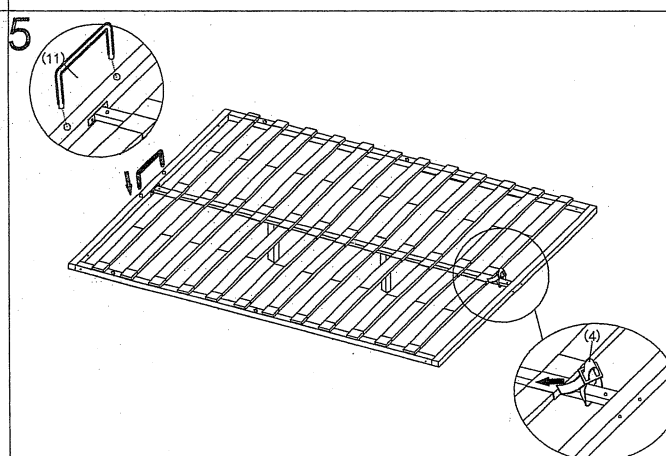

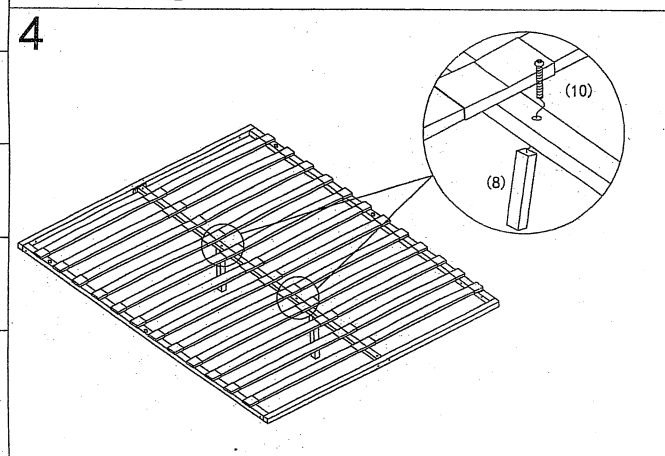

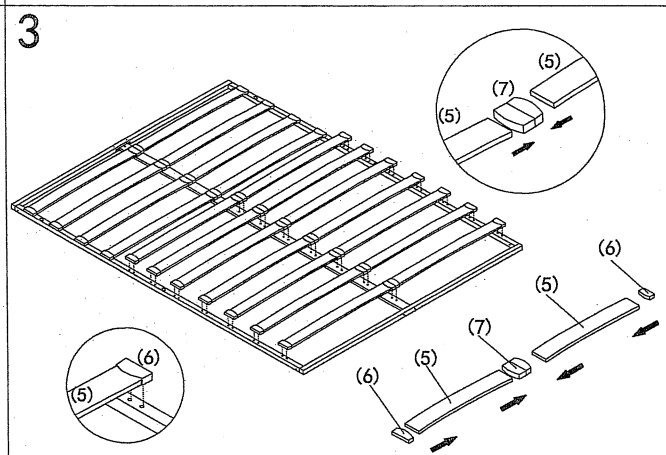

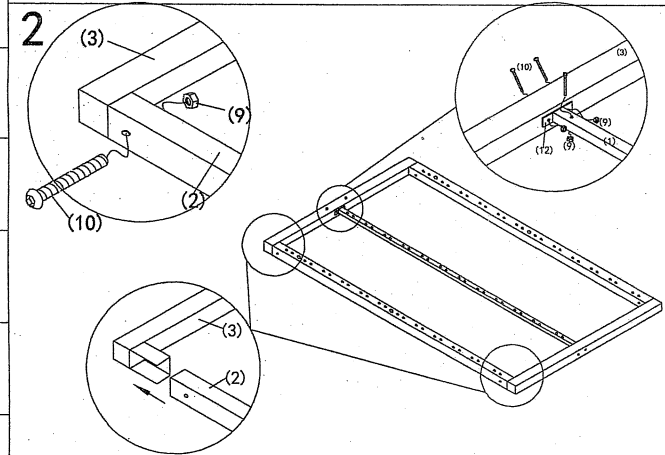

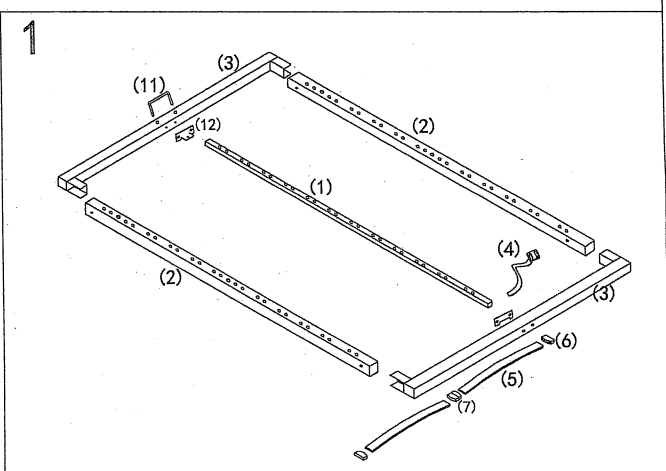
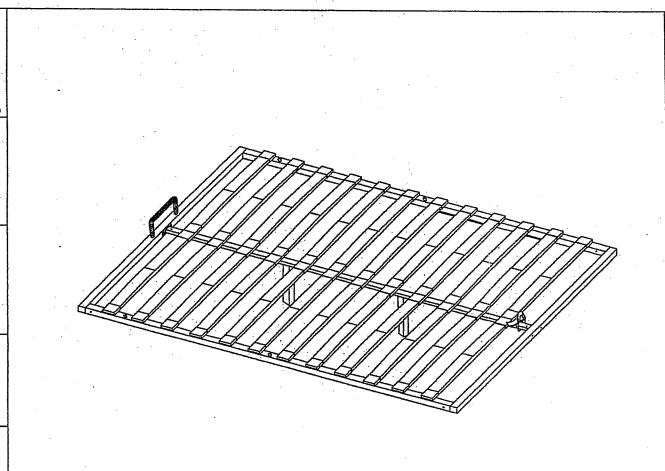
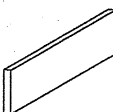
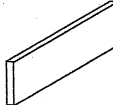
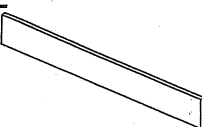
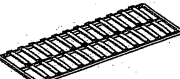



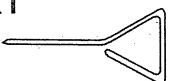

234-000004

- | | |
|---------|----------|
| (1) x1 | (2) x2 |
| (3) x2 | (4) x1 |
| (5) x26 | (6) x26 |
| (7) x13 | (8) x2 |
| (9) x10 | (10) x12 |
| (11) x1 | (12) x2 |

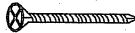

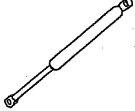
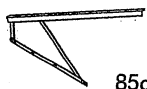
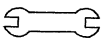
Ax1 	Bx1 
Cx2 	Dx1 
Ex42  (8*20)	Fx1 
Gx4 	Hx6 
Ix1 	Jx5 
Kx1 	Lx1 
Mx4 	Nx4  (5*50)
Ox4  4cm	Px2 
Qx2  85cm	Rx1 
Sx16  (3.5*20)	Tx1 

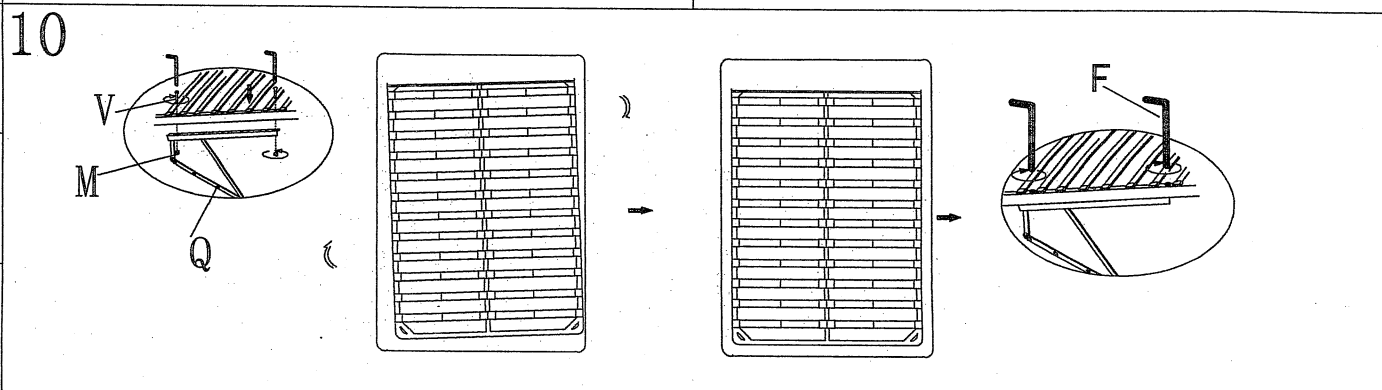
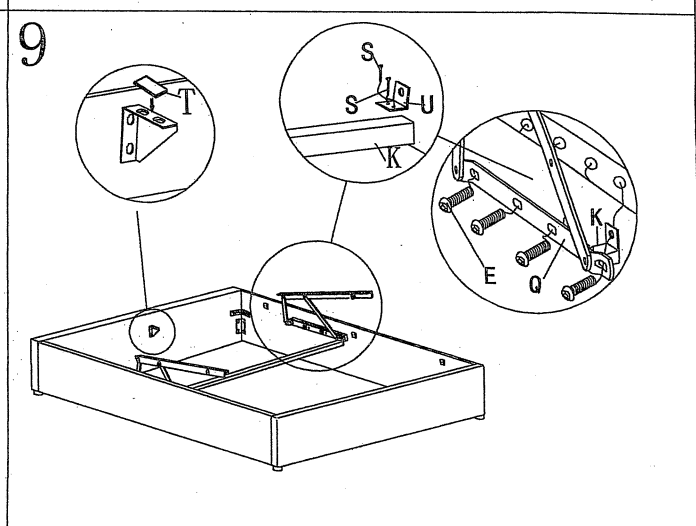
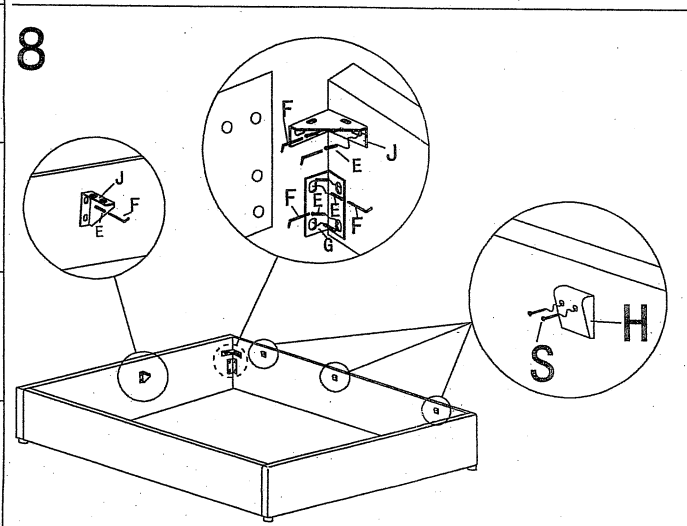
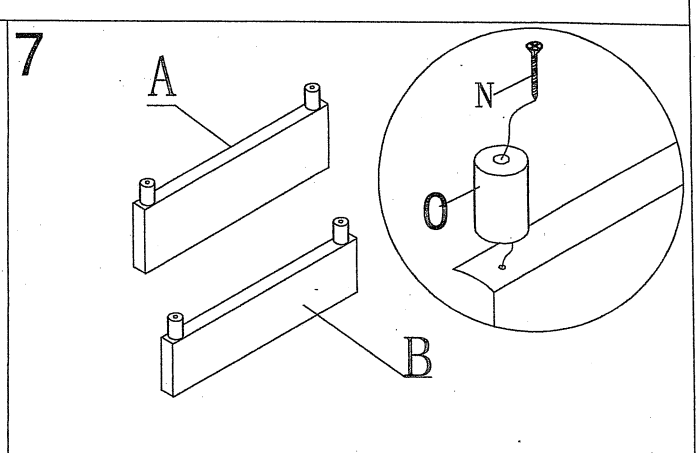
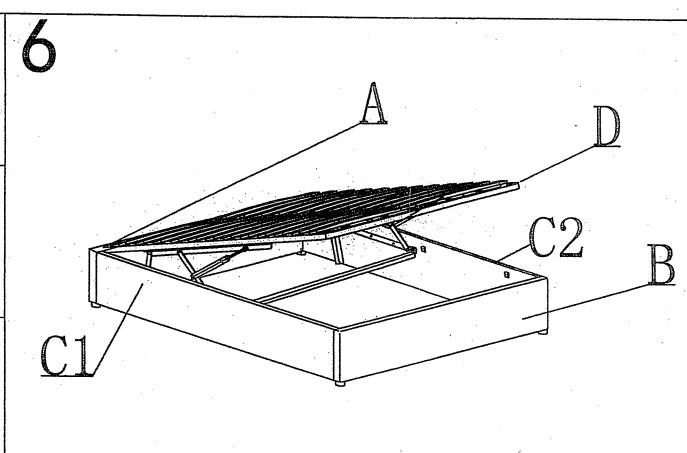

Ux2



Vx4

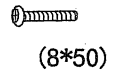

11

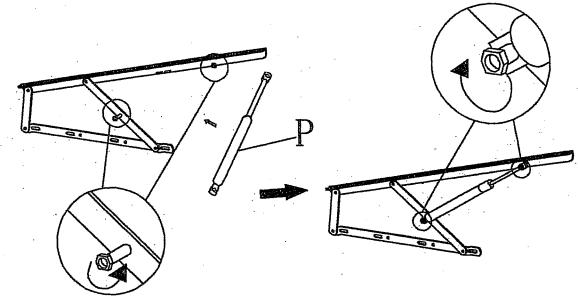
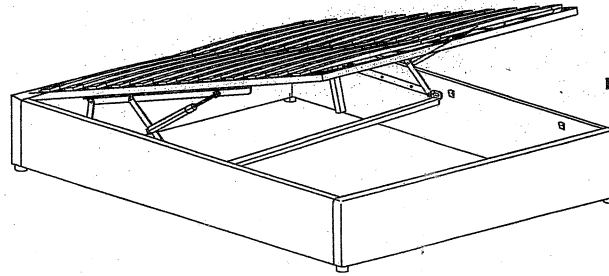

12

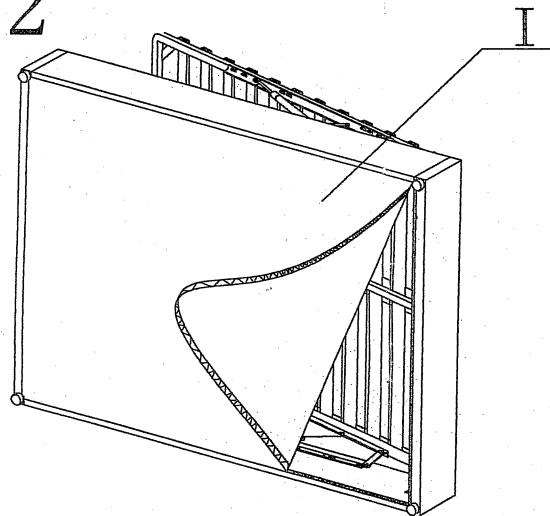

13

