

A	B	C	D	A	B	C	D		
1	KR1-009	2029	906	3/3	8	KR1-307	878	460	2/3
2	KR1-006	2029	906	3/3	9	KR1-324	878	455	2/3
3	KR1-110	2155	608	1/3	10	KR1-417	1772	80	2/3
4	KR1-111	2155	608	1/3	11	KR1-403	1772	80	2/3
5	KR1-106	2042	460	1/3	12	KR1-920	1634	893	3/3
6	KR1-322	1772	583	2/3	13	KR1-921	422	893	3/3
7	KR1-323	1772	566	2/3	14	DR-873	873		1/3
					15		1771	20	1/3

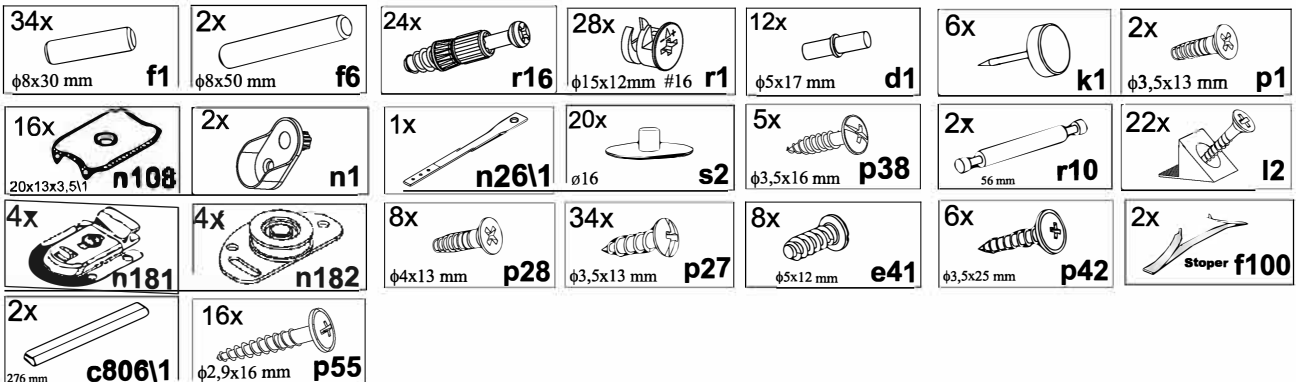

1

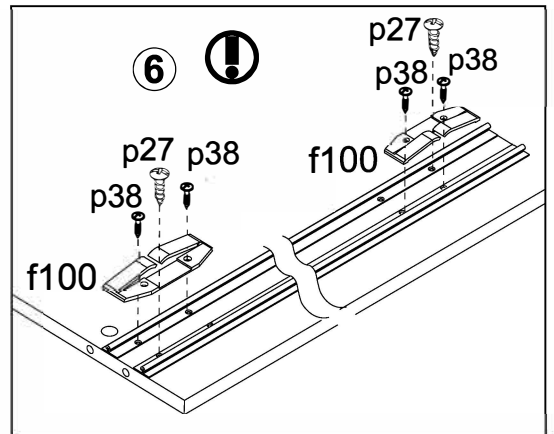
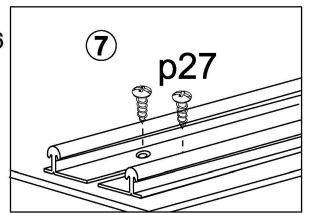
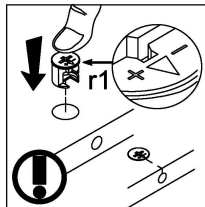
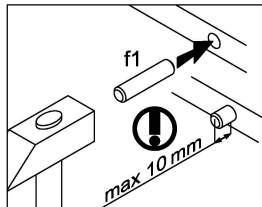
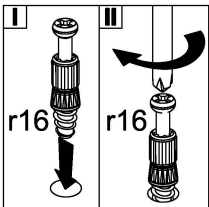
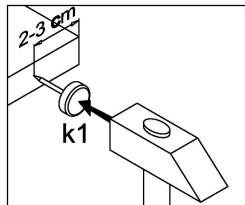
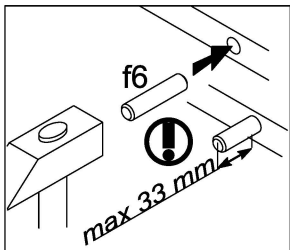
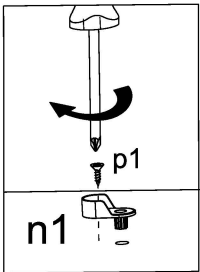
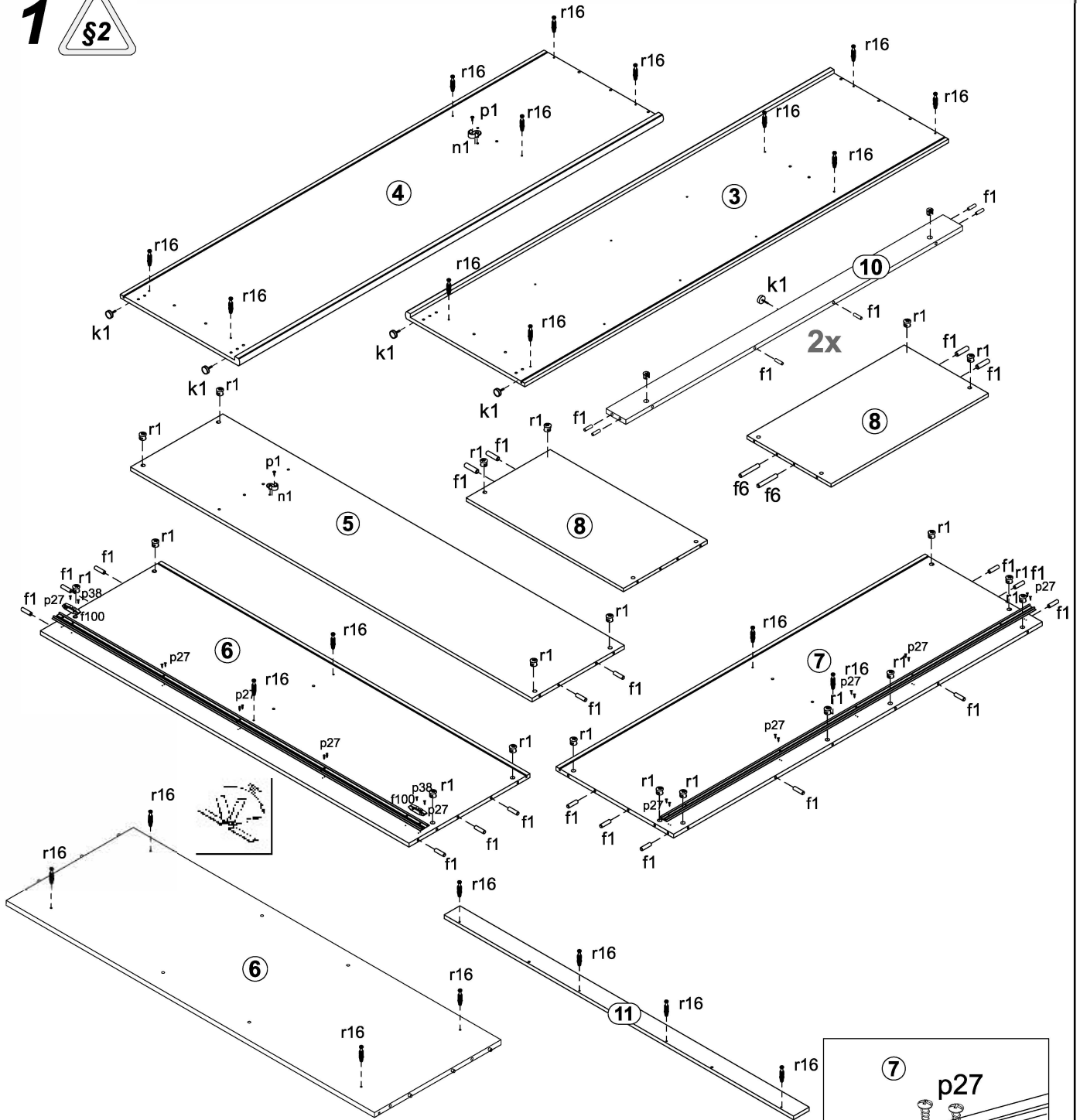

2

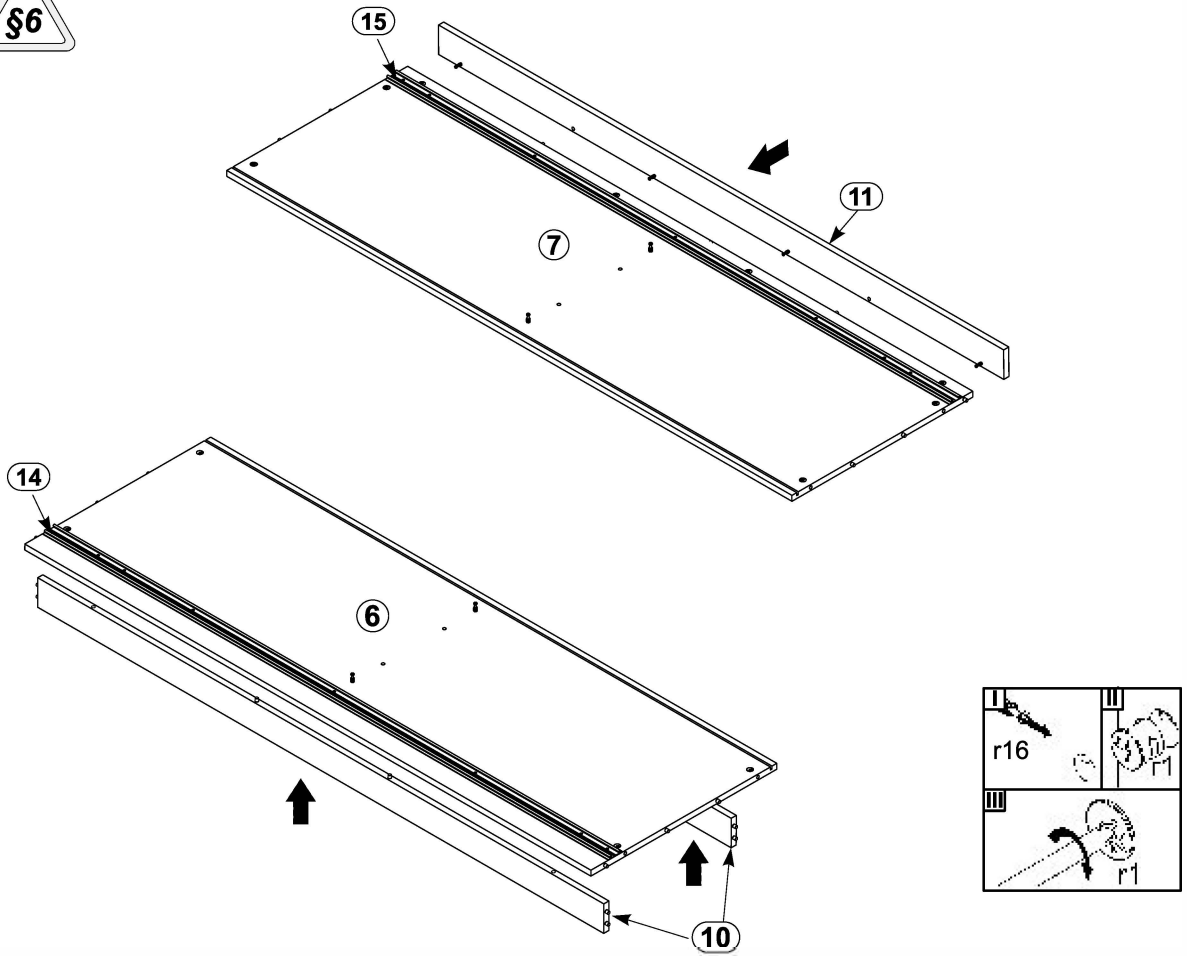

3

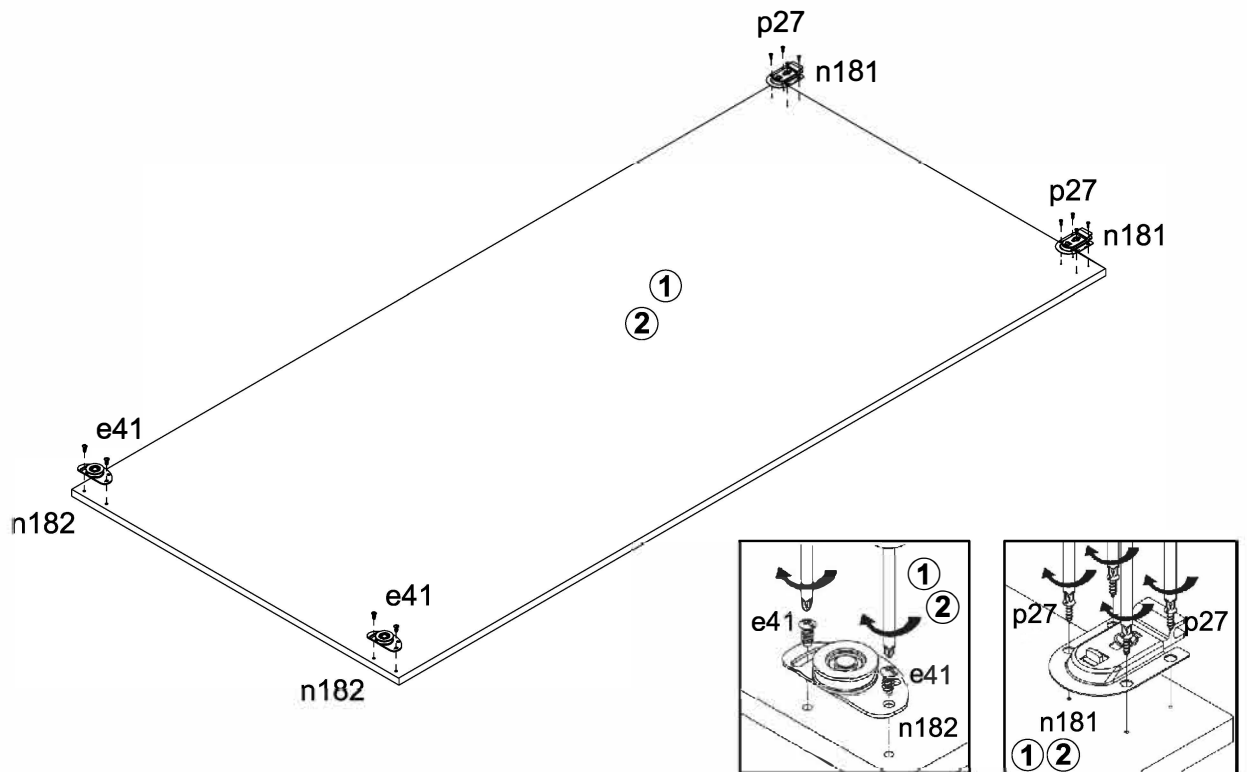

4

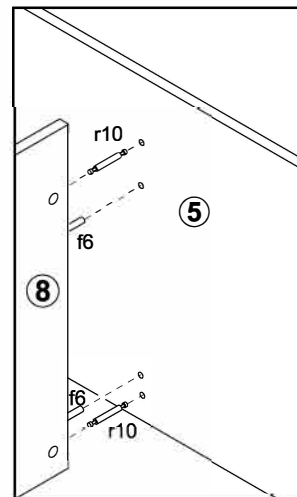
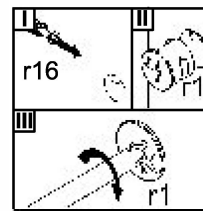
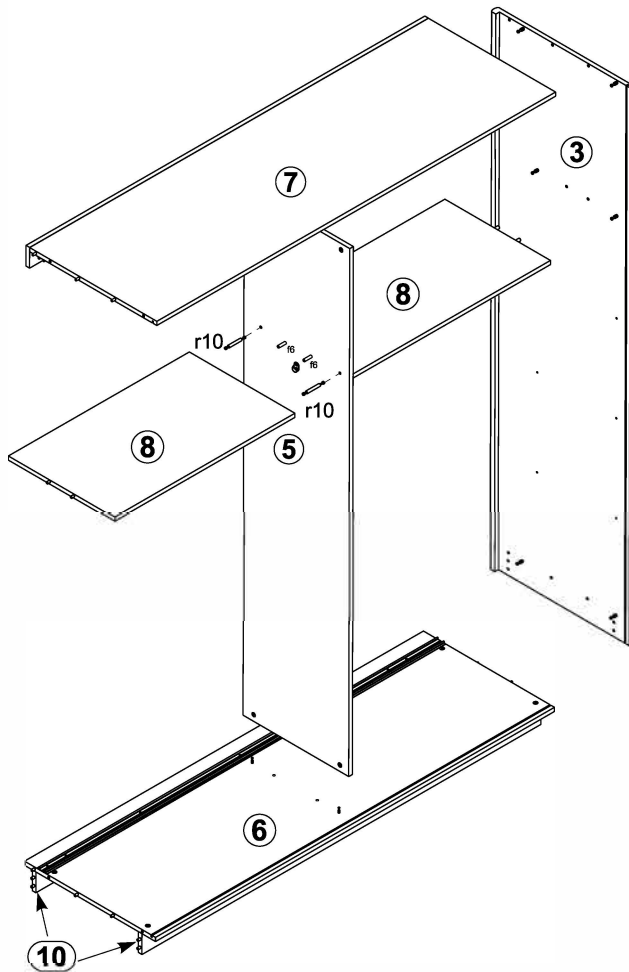
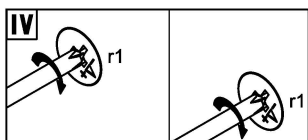
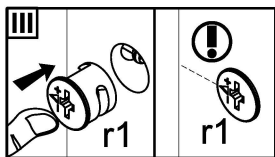
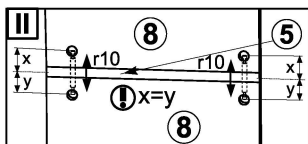
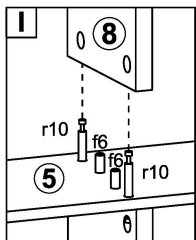

5

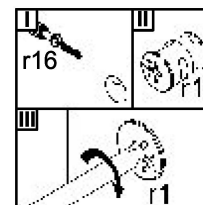
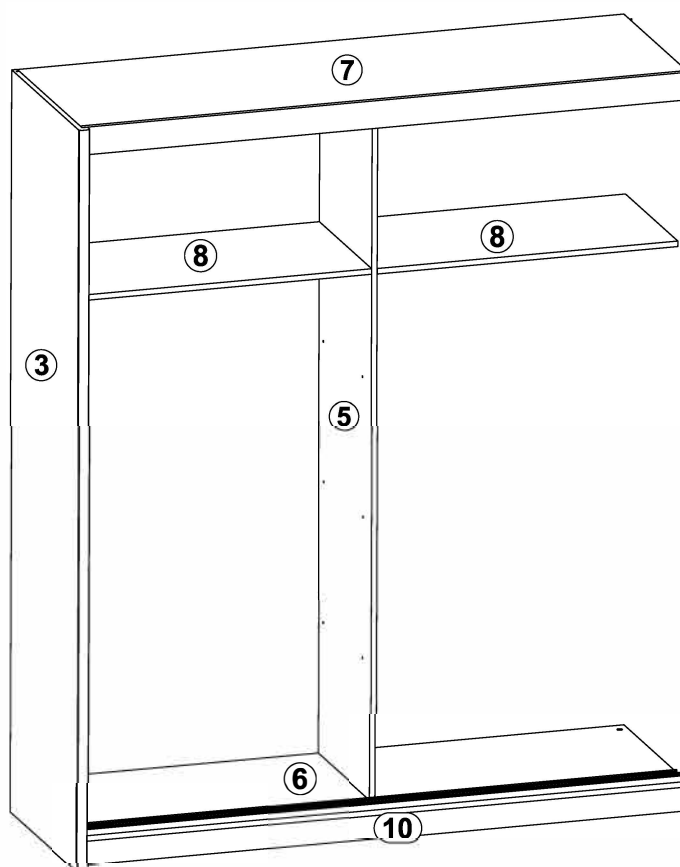

6

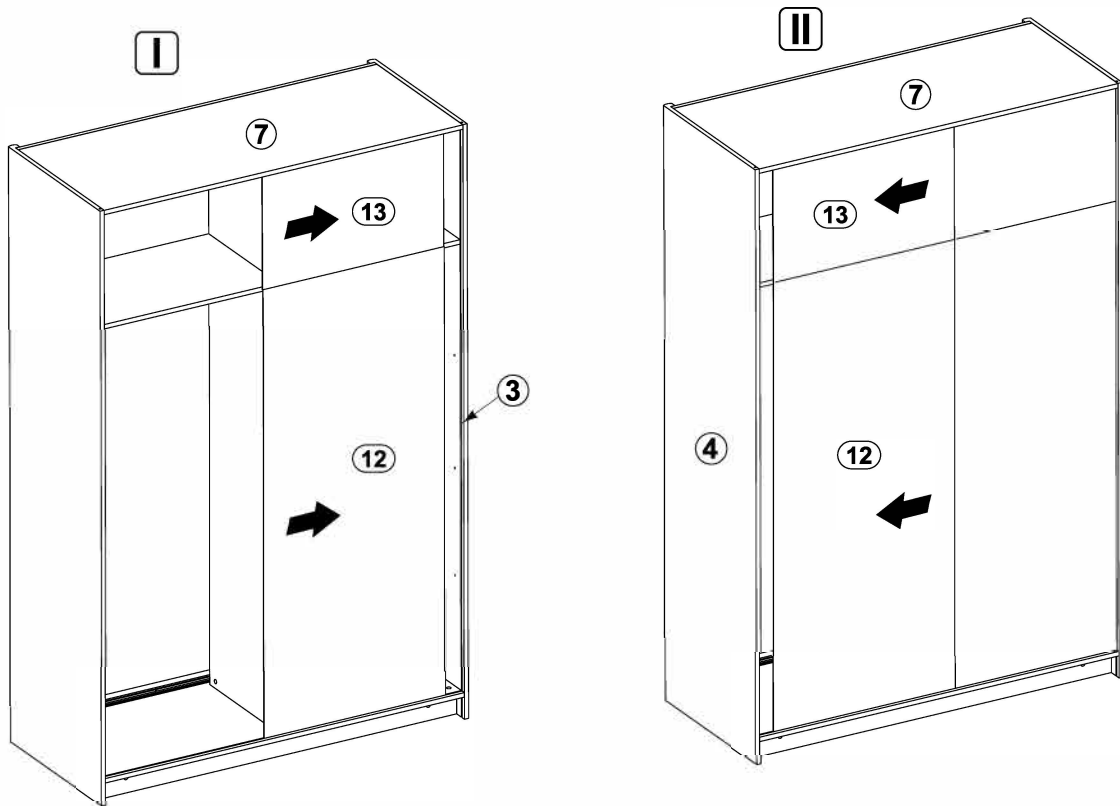

7

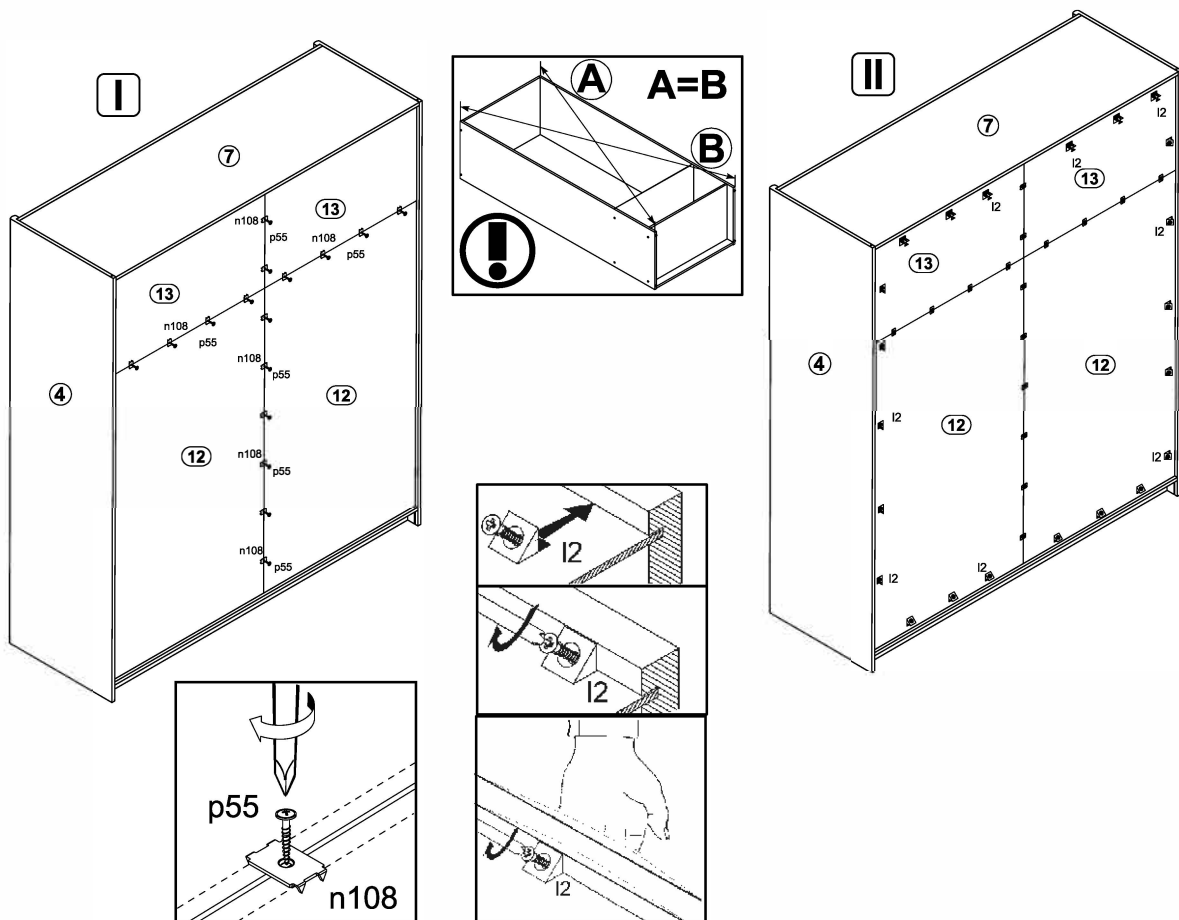

8

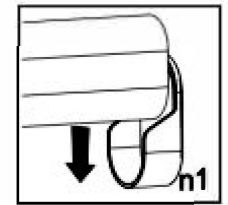
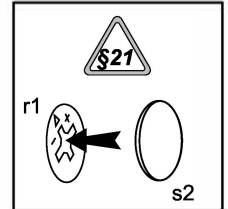
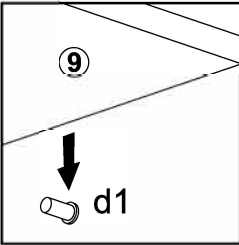
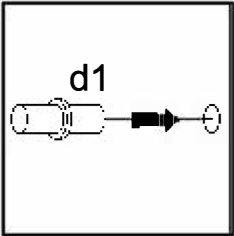
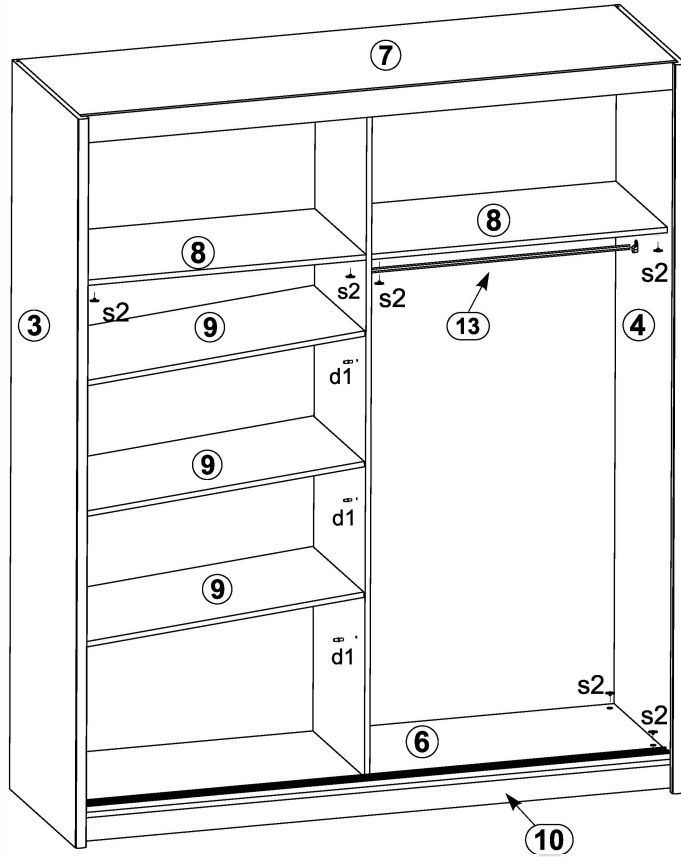

9

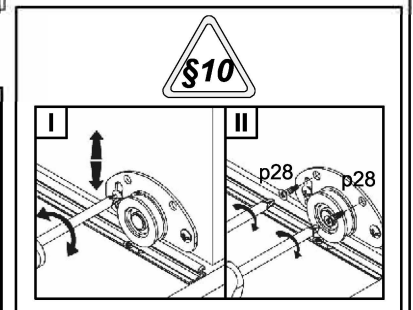
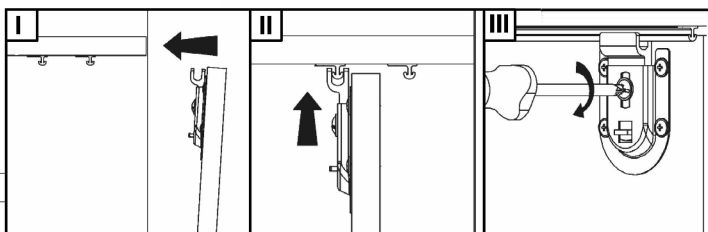
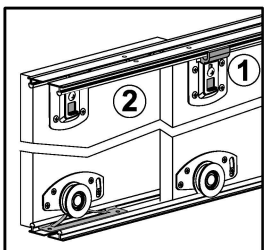
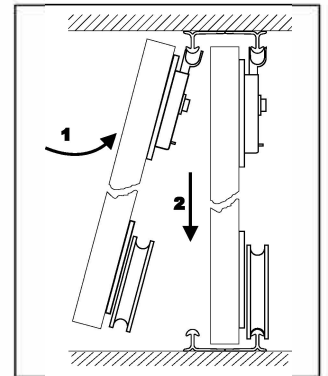
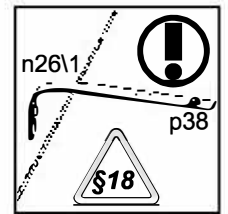
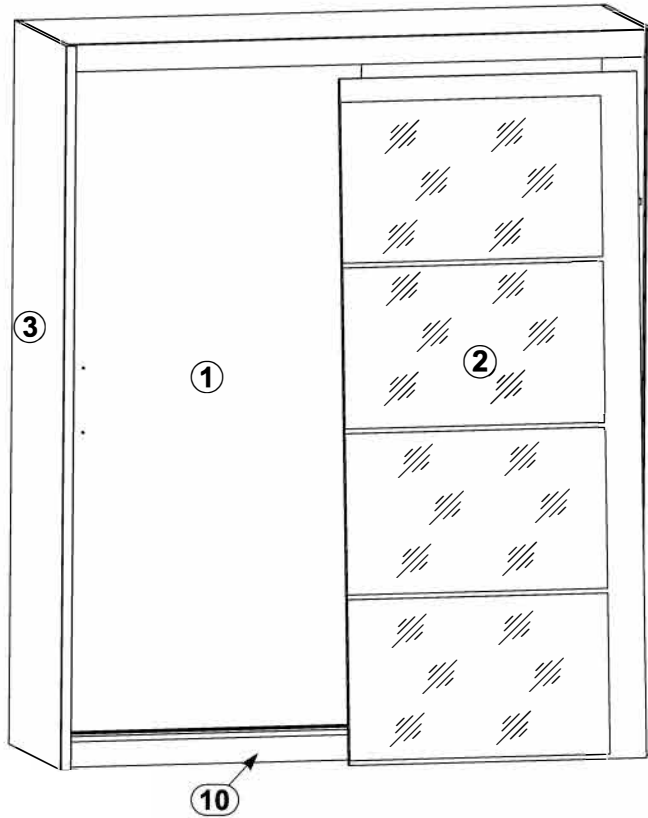
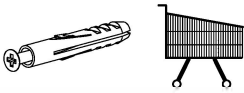

10

