

Dear Customer,

We design and produce our product for people to love and have fun with them as we do.

The product you bought was subjected to all sorts of tests and control before sending out to you.

Before start assembling, please check the whole components and accessories according to the lists. If you bought more than one product, to prevent confusion be sure that you completed the first product. Then start the other product's assembling.

Before start assembling, please clean all the components with a damp cloth. Also for usual cleaning, this will be enough.

Although all the products are produced and packed carefully, sometimes happen that some component is damaged during the transportation. In such a case please check the missing or damaged part and do not hesitate to contact us.

Do not use furniture for other purposes. If you would like to use it, please contact us for further questions.









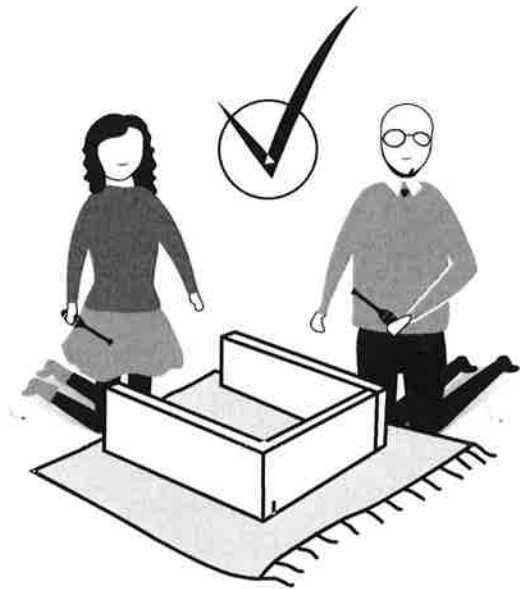

Do not directly contact your furniture with excessive heat, cold and humidity because the product can be affected.

## WARNING

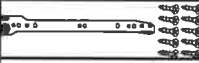
Serious or fatal crushing injuries can occur from furniture tip-over. To prevent this furniture from tipping over it must be permanently fixed to the wall with the included wall attachment devices.

Fixing devices for the wall are not included since different wall materials require different types of fixing devices. Use fixing devices suitable for the walls in your home. For advice on suitable fixing systems, contact your local specialized dealer.

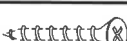
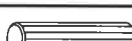

HARDWARE LIST			
NO	DESCRIPTION		QTY
I	JCBCW SCREW M6.3 x 50		18pcs
II	M4 ALLEN KEY		1pc
III	HANDLE & SCREW M4 x 12		3sets
IV	HANDLE & SCREW M4 x 22		2sets
V	12" DRAWER SLIDER & SCREW M3.5 x 14		3sets
VI	HINGE (C) & SCREW M3.5 x 14		4sets
VII	PVC NAIL WITH PIN		8pcs
VIII	NAIL		60pcs
IX	Q-FIT		20sets
X	M8 X 32 CHIPBOARD SCREW		12pcs
XI	PLASTIC DOWEL		8pcs
XII	M4 x 25 CHIPBOARD SCREW		16pcs
XIII	STICKER		4pcs

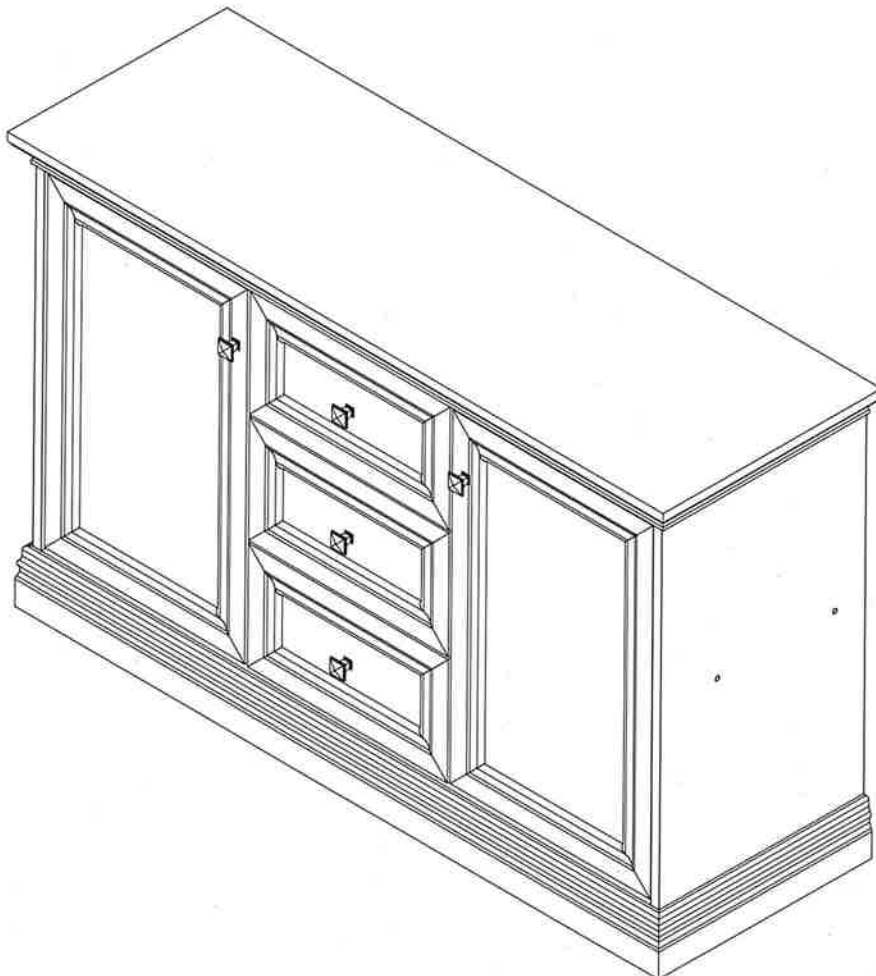

# STEP 1

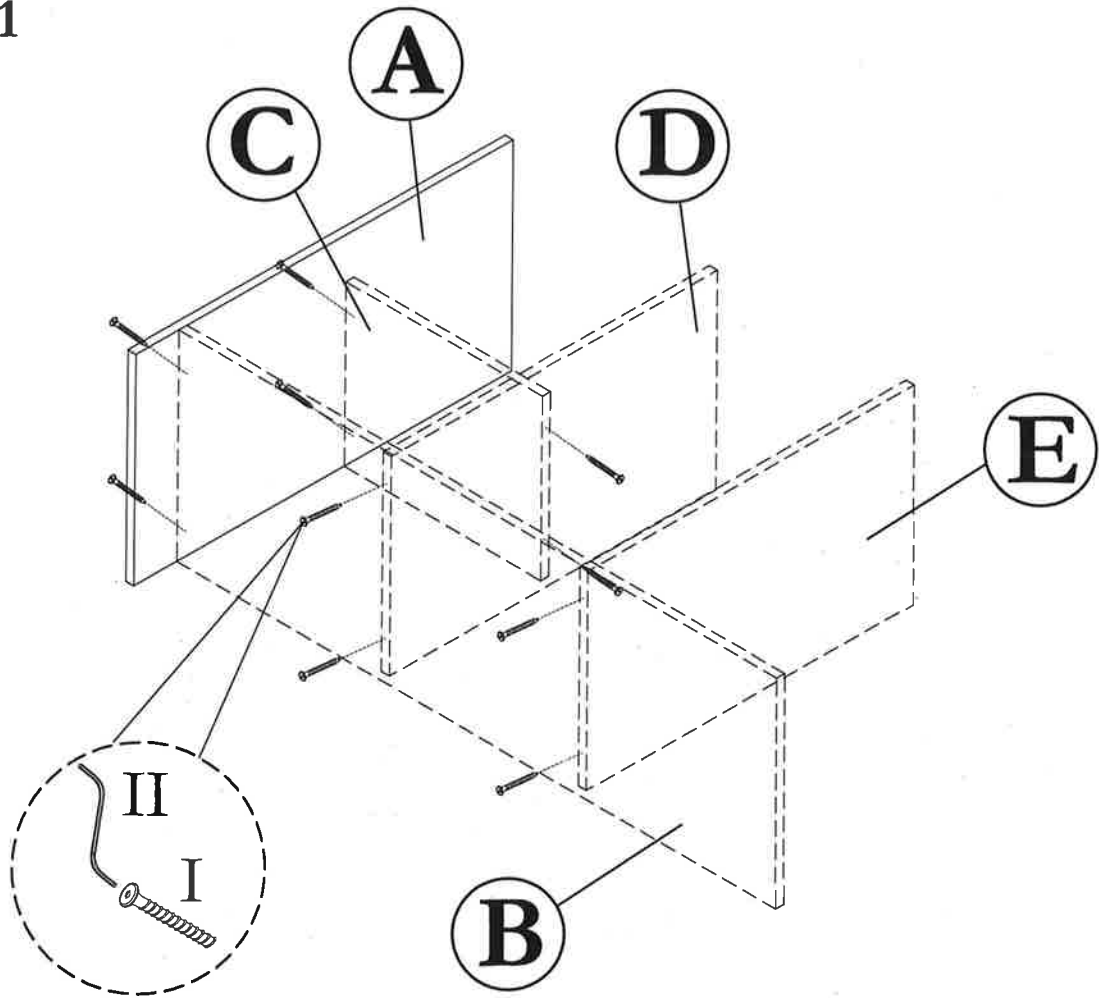

# STEP 2

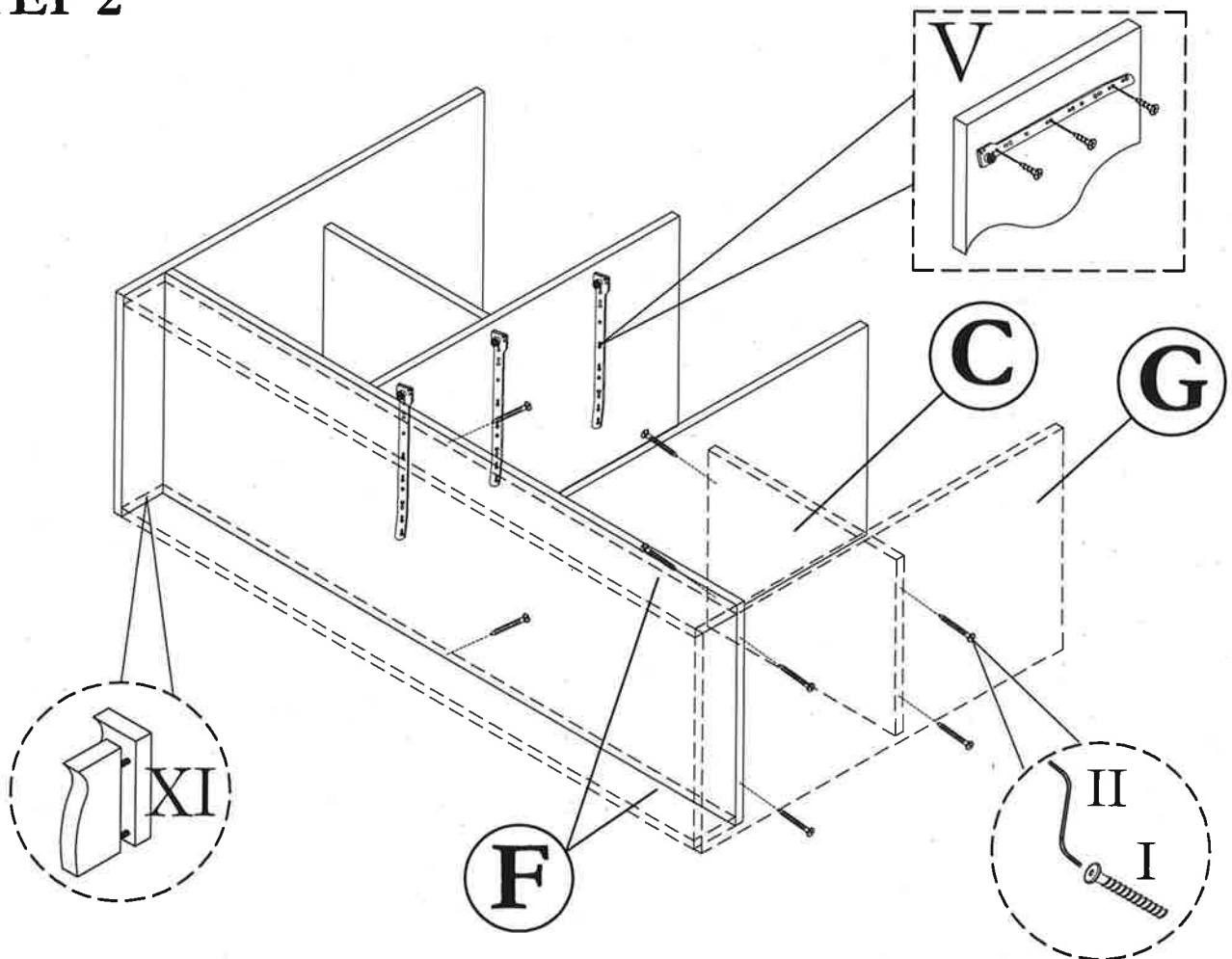

### STEP 3

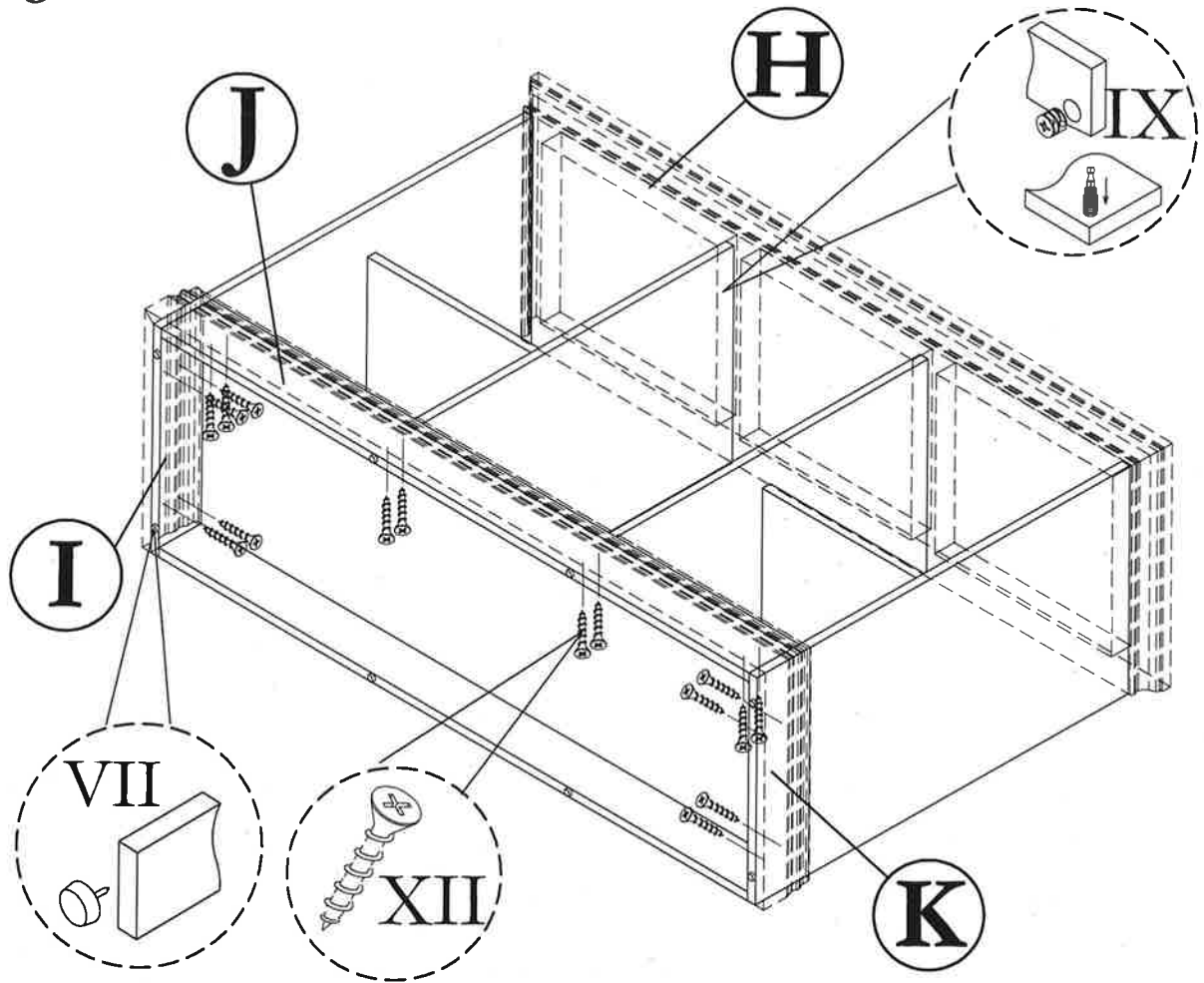

### STEP 4

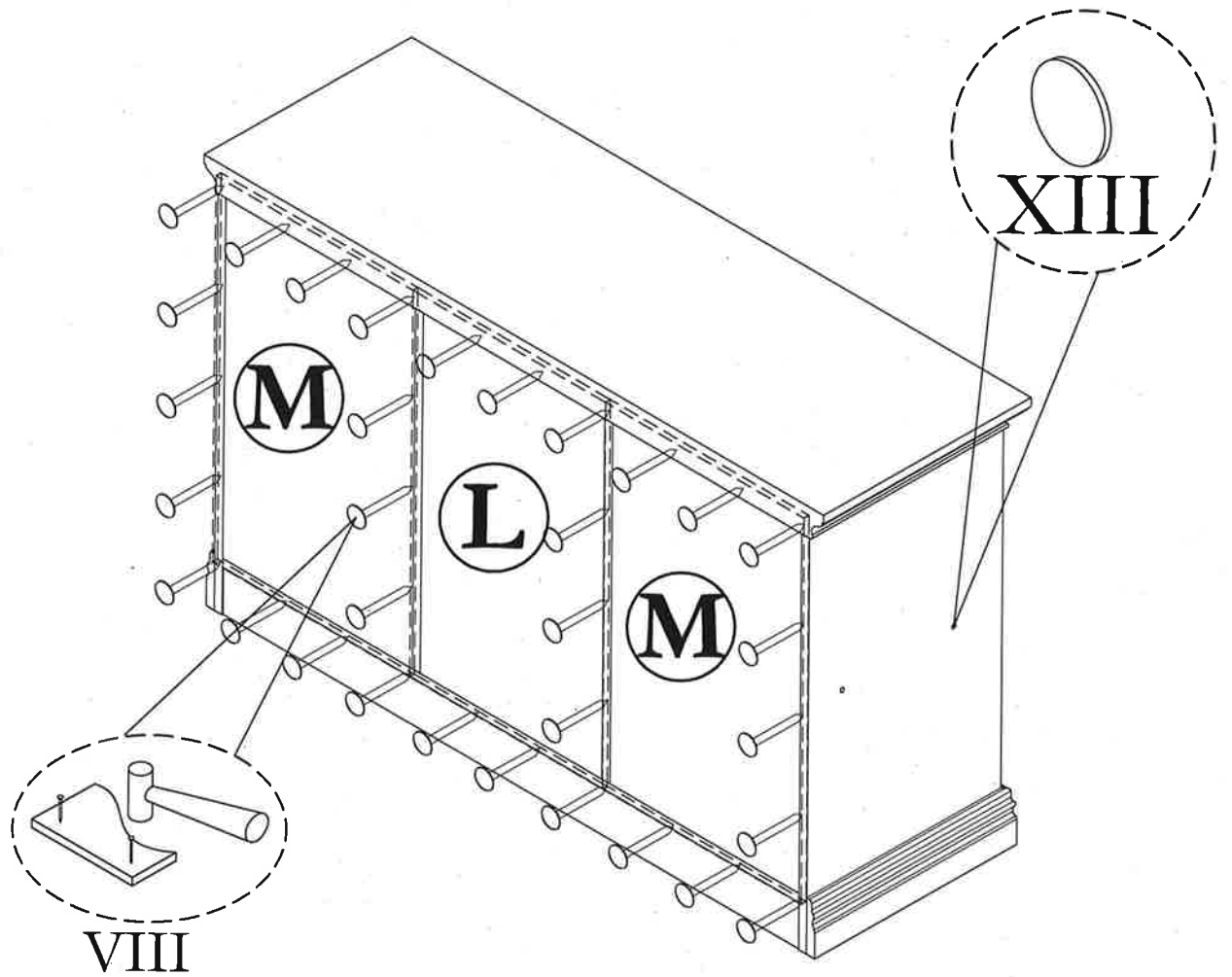

# STEP 5

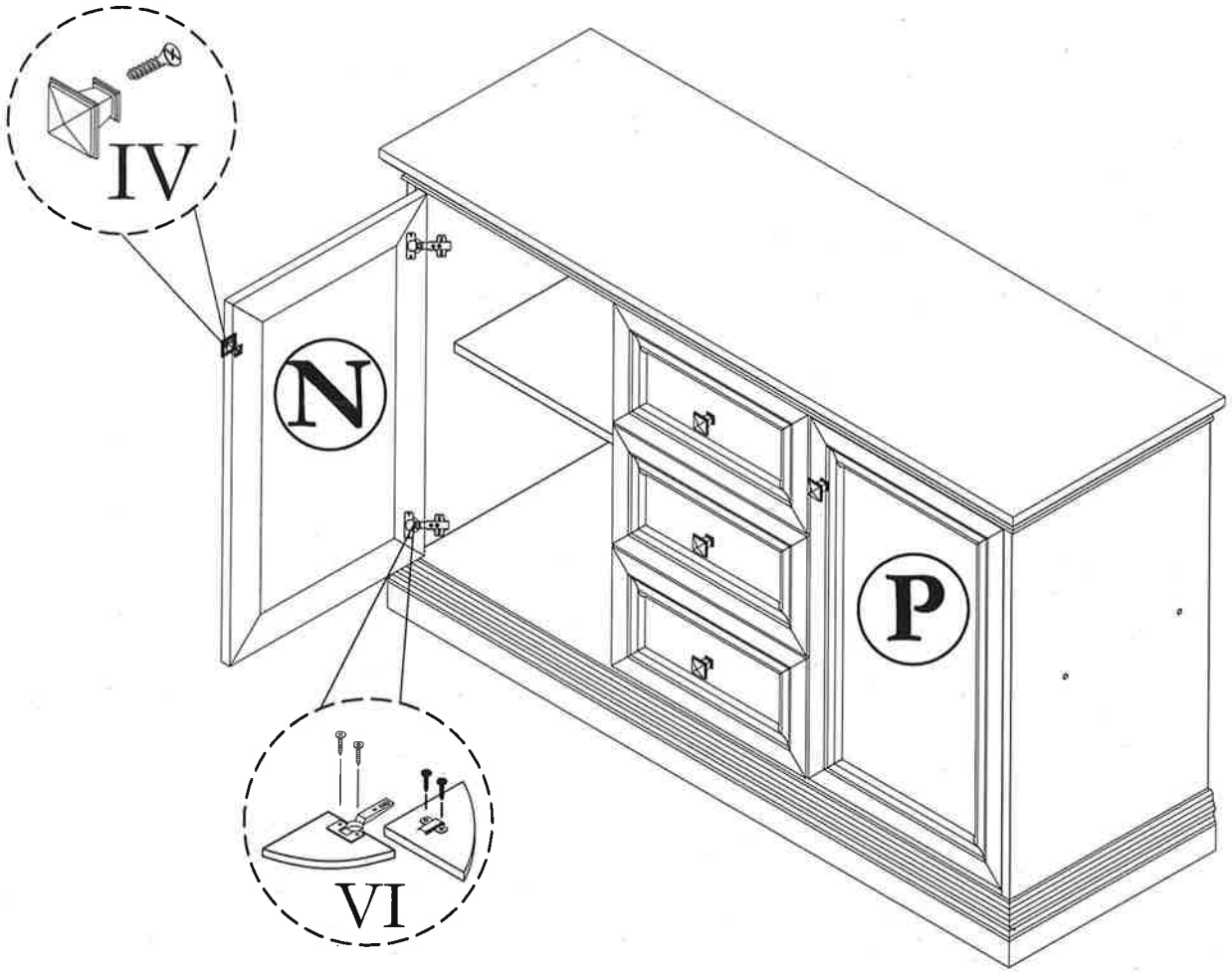

# STEP 6

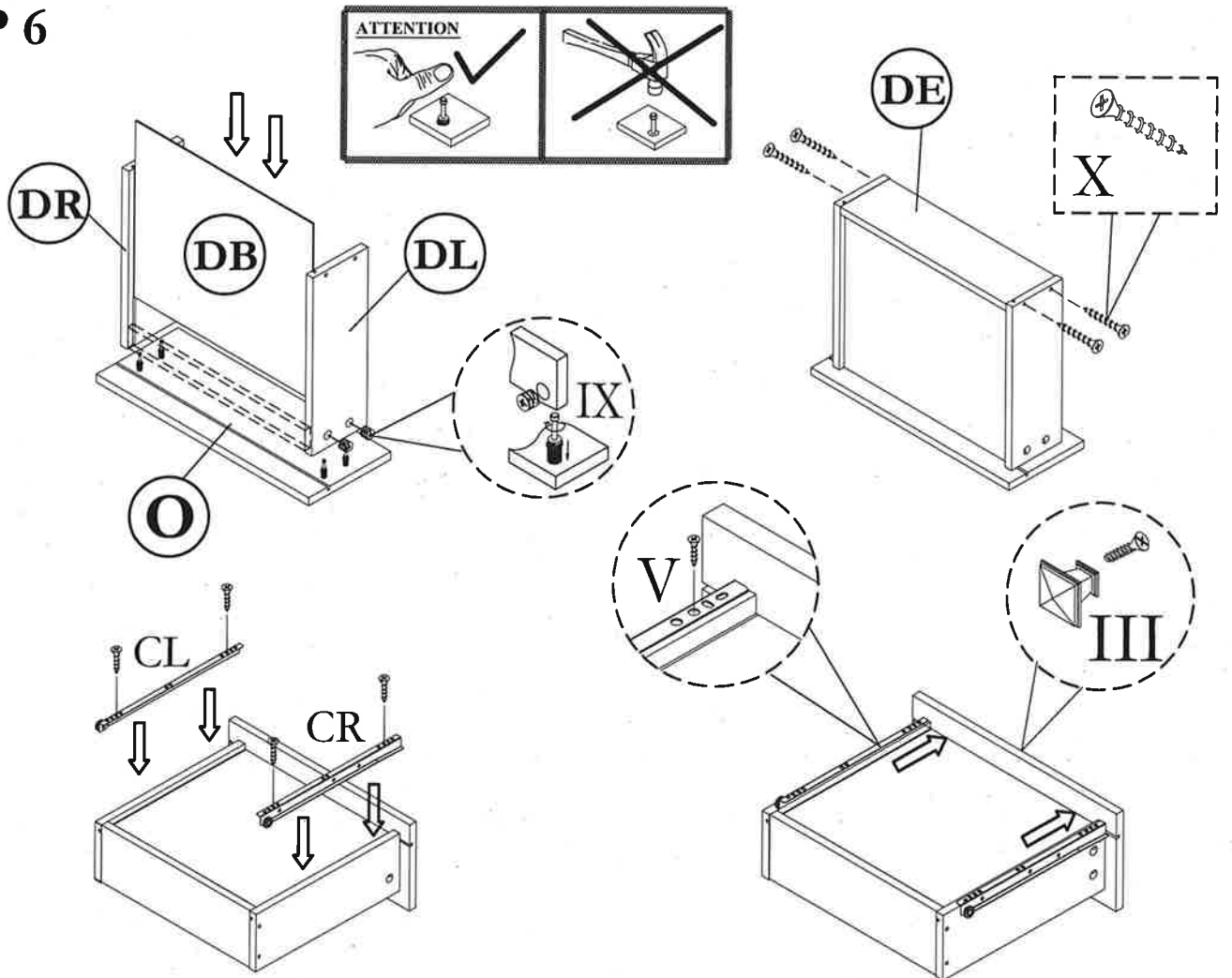

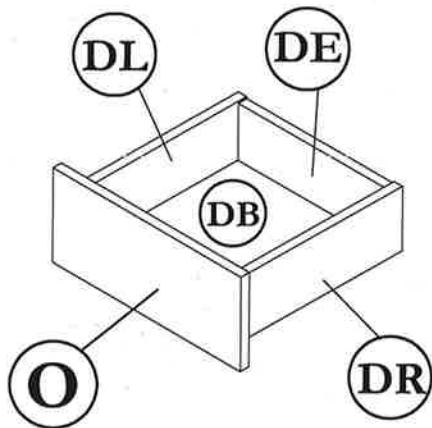
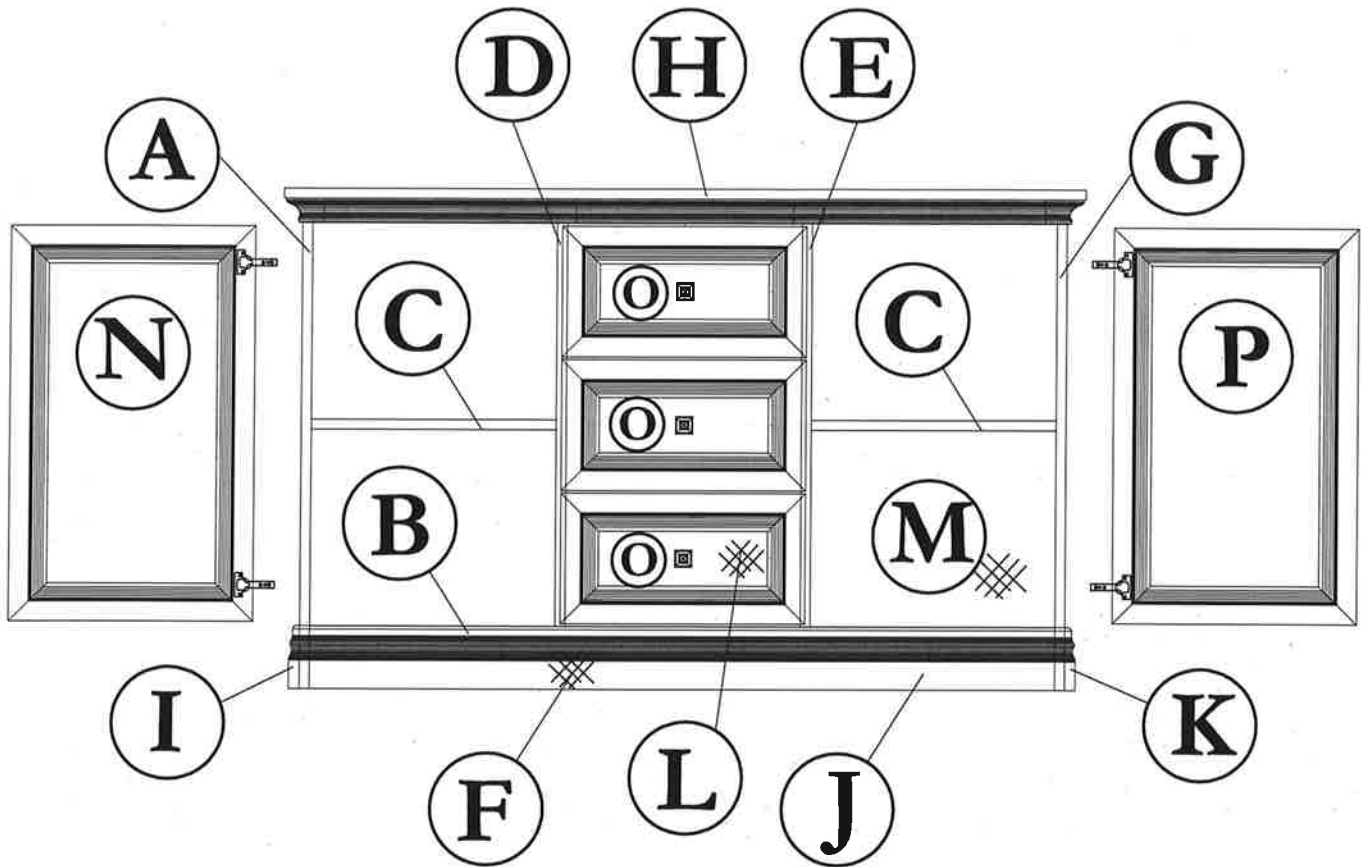

NO	DESCRIPTION	QTY
DL	DRAWER SIDE (Left)	03
DR	DRAWER SIDE (Right)	03
DB	DRAWER BASE	03
DE	DRAWER END	03

NO	DESCRIPTION	QTY
A	LEFT SIDE	01
B	LOWER SHELF	01
C	CENTRE SHELF	02
D	CENTRE VERTICAL	01
E	CENTRE VERTICAL	01
F	LEG	02
G	RIGHT SIDE	01
H	TOP	01

NO	DESCRIPTION	QTY
I	LEFT SIDE WRAPPING	01
J	FRONT WRAPPING	01
K	RIGHT SIDE WRAPPING	01
L	BACK (Centre)	01
M	BACK (Left & Right)	02
N	LEFT SIDE DOOR	01
O	DRAWER FACE	03
P	RIGHT SIDE DOOR	01