

Assembly Drawing

Pakketo code:069-000040

Size:800X400X800

Tools

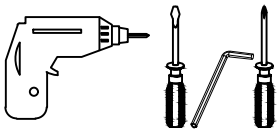

Connecting Parts

A		16	G		20
B		9	H		4
C		2	J		4
D		1	K		
E		1	L		
F		4	M		

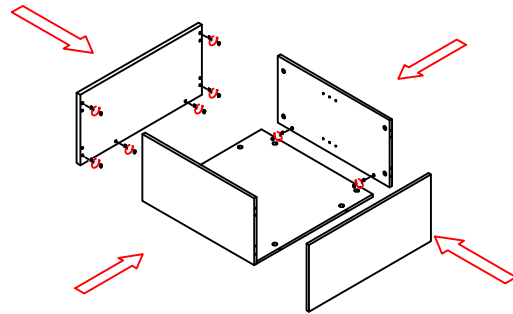

1

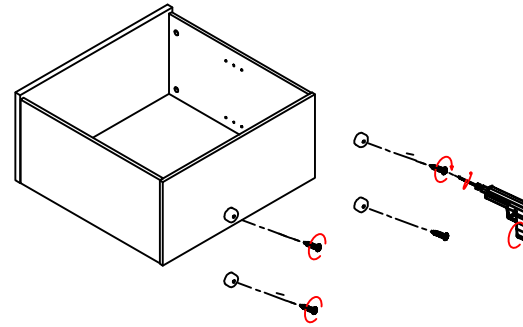

2

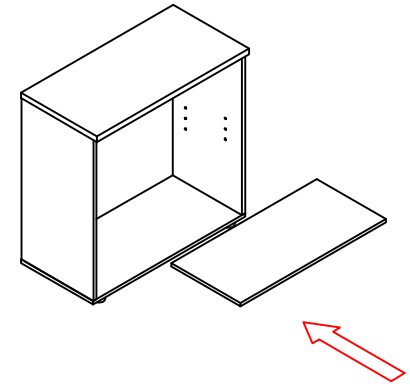

3

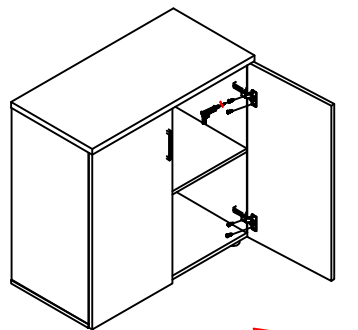
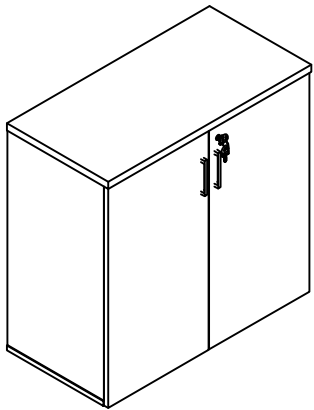

4

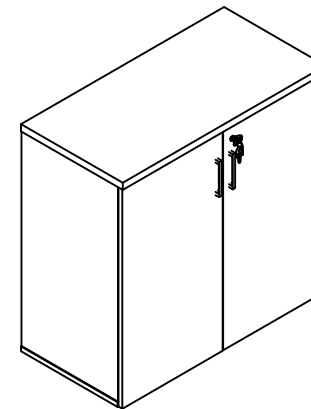

5