

Assembly Drawing

Pakketo code:069-000029

Tools

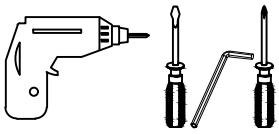

Connecting Parts

A		62	G		30
B		20	H		4
C		2	J		1
D		1	K		1
E		2	L		
F		4	M		

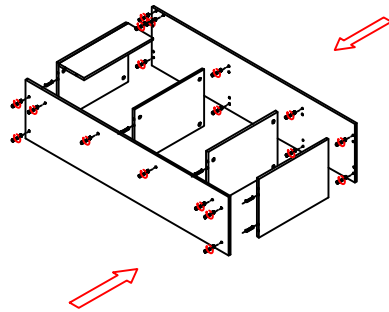

1

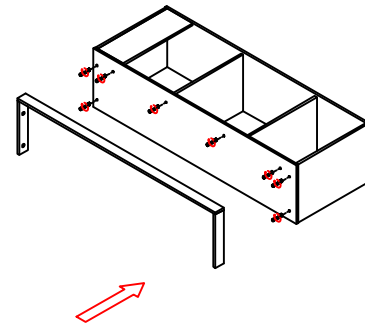

2

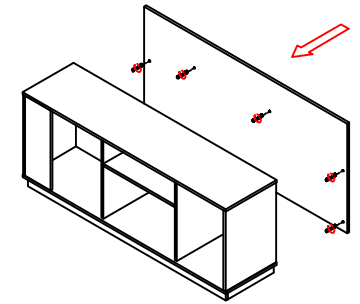

3

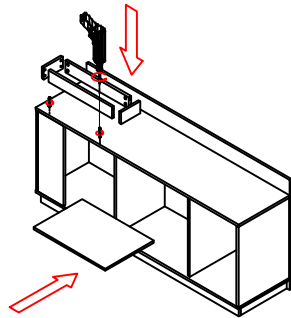

4

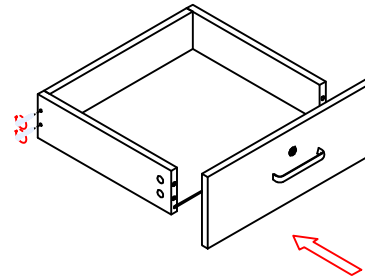

5

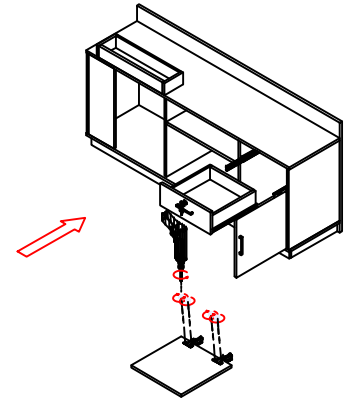

6

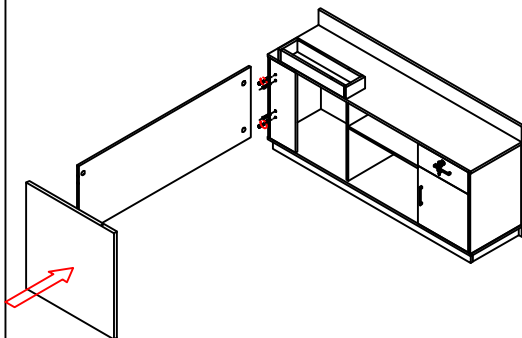
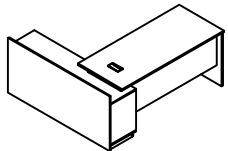
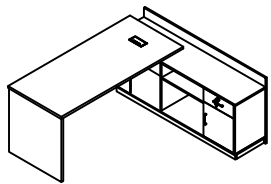

7

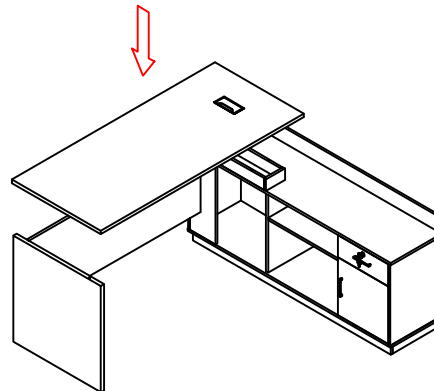

8

Finish