

Assembly Instruction

049-000062

Hardware List			
No.	SHAPE	DESCRIPTION	Qty.
A		8x25mm Dowel	12Pcs
B		15MM Myfix Minifix	6Sets
C		M4x65mm Screw	6Pcs
D		5/8 Nail With Pin	4Pcs

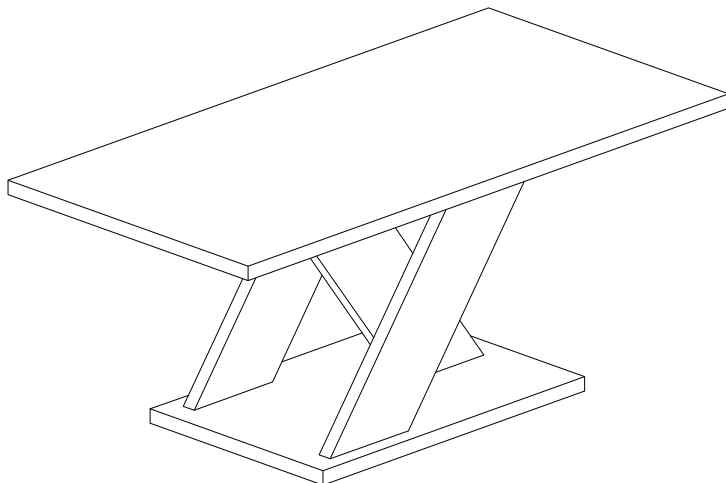

Part List

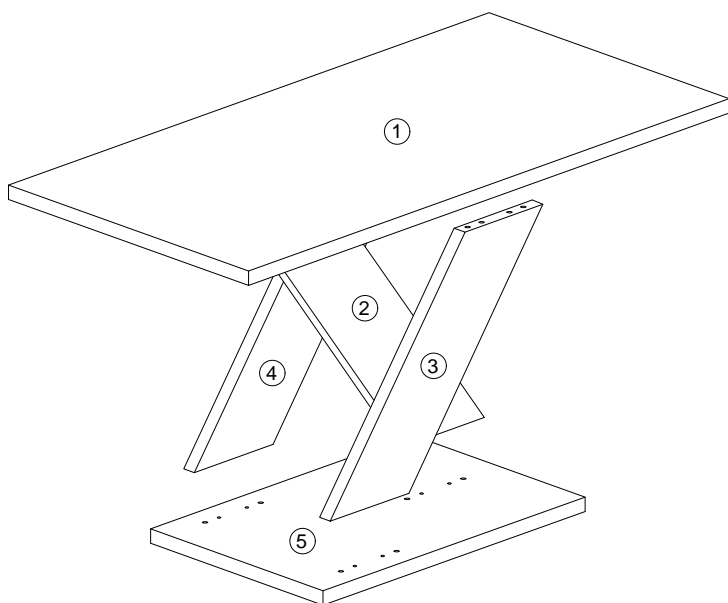

Step 1

A		8x25mm Dowel	12Pcs
---	---	--------------	-------

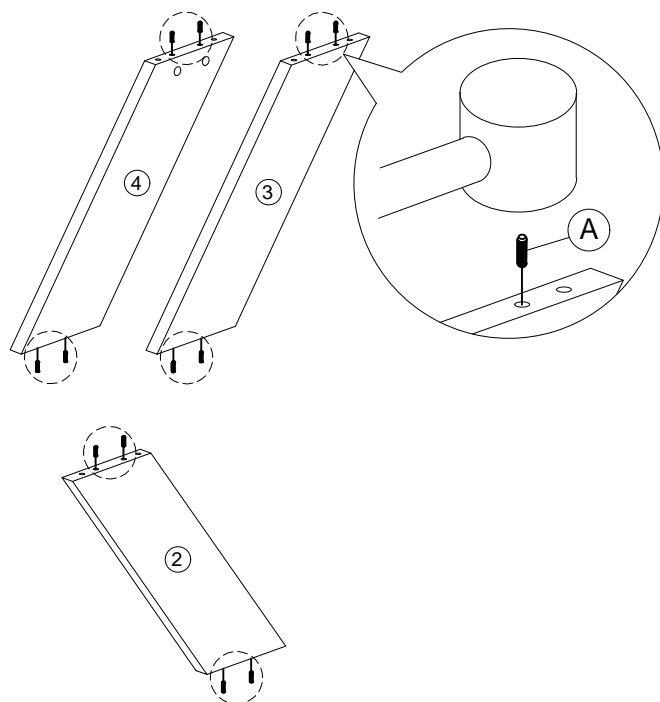

Assembly Instruction

Step 2

D		5/8 Nail With Pin	4Pcs
---	---	-------------------	------

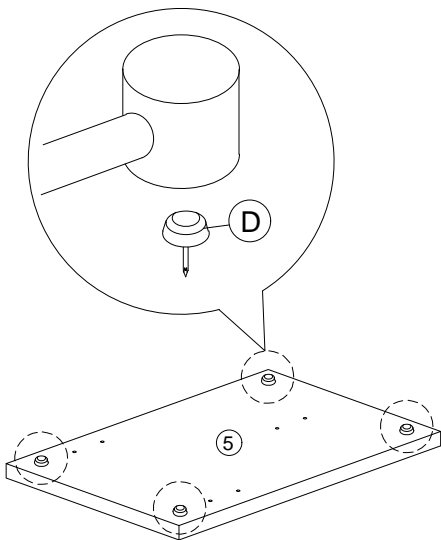

Step 3

B		Myfix	6Pcs
---	---	-------	------

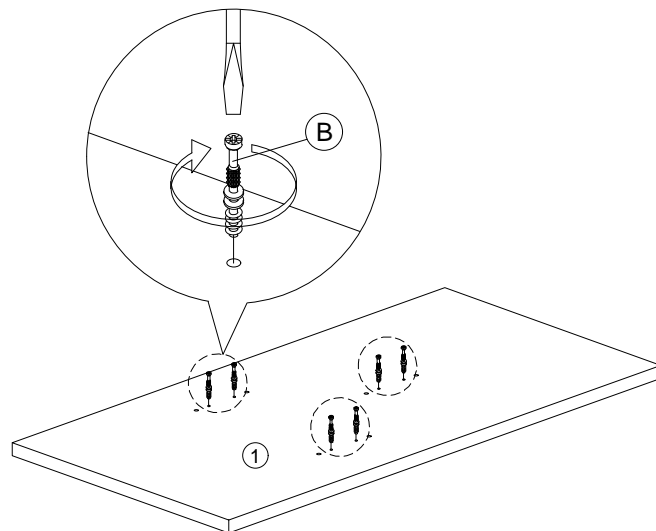

Step 4

B		Minifix	6Pcs
---	---	---------	------

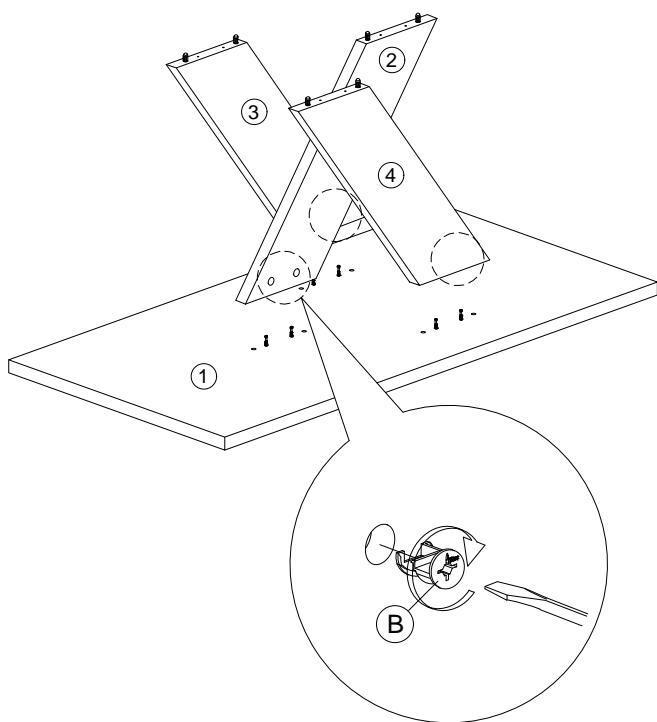

Step 5

C		M4x65mm Screw	6Pcs
---	---	---------------	------

