

















# ASSEMBLY INSTRUCTION

**IMPORTANT NOTE:**

- ※PLACE ALL PARTS ON A CLEAN AND SMOOTH SURFACE SUCH AS A RUG OR CARPET TO AVOID THE PARTS FROM BEING SCRATCHED.
- ※KINDLY FOLLOW THE ASSEMBLY INSTRUCTIONS STEP BY STEP.
- ※DO NOT TIGHTEN ALL SCREWS UNTIL THE BED IS FULLY SET-UP.

PARTS LIST & HARDWARE LIST					
<b>1:HEAD BOARD</b> <b>1pc</b> 	<b>2:FOOT BOARD</b> <b>1PC</b> 	<b>3:SIDE RAIL</b> 2PCS 	<b>4:DOUBLE PLASTIC CAP</b> <b>12PCS</b> 	<b>5:CENTER SUPPORT BAR</b> <b>1PCS</b> 	<b>6 : SUPPORT LEG</b> <b>2PCS</b> 
<b>7:SLAT</b> 24PC 	<b>8: SINGLE PLASTIC CAP</b> <b>24PCS</b> 	<b>9 : LEG</b> 4PCS 			
<b>A:BOLT</b> 4PCS  M8X75mm	<b>B:BOLT</b> 8PCS  M8X40mm	<b>C:BOLT</b> 8PCS  M8X30mm	<b>D:SPRING WASHER</b> <b>20PCS</b> 	<b>E:FLAT WASHER</b> <b>20PCS</b> 	<b>F:ALLEN KEY</b> <b>1PC</b>  <b>M8</b>
<b>G:NUT</b> 4PCS  M8	<b>H:SPANNER</b> <b>1PCS</b> 				

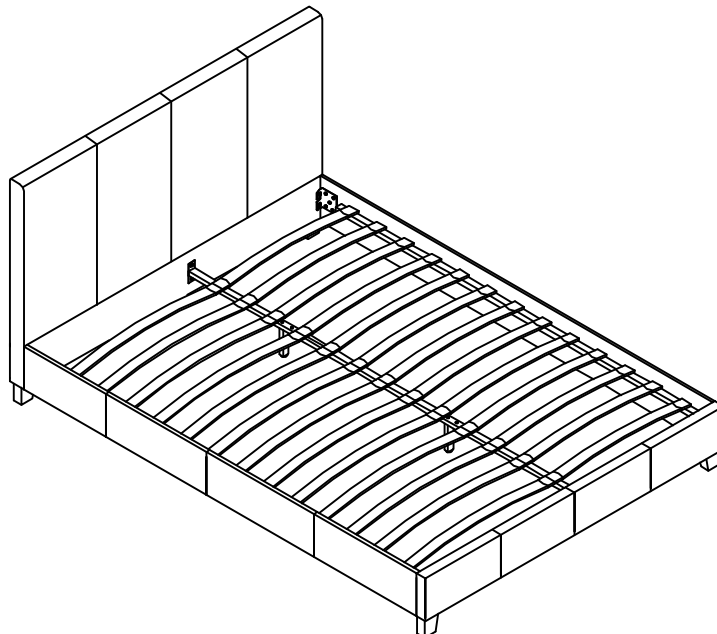

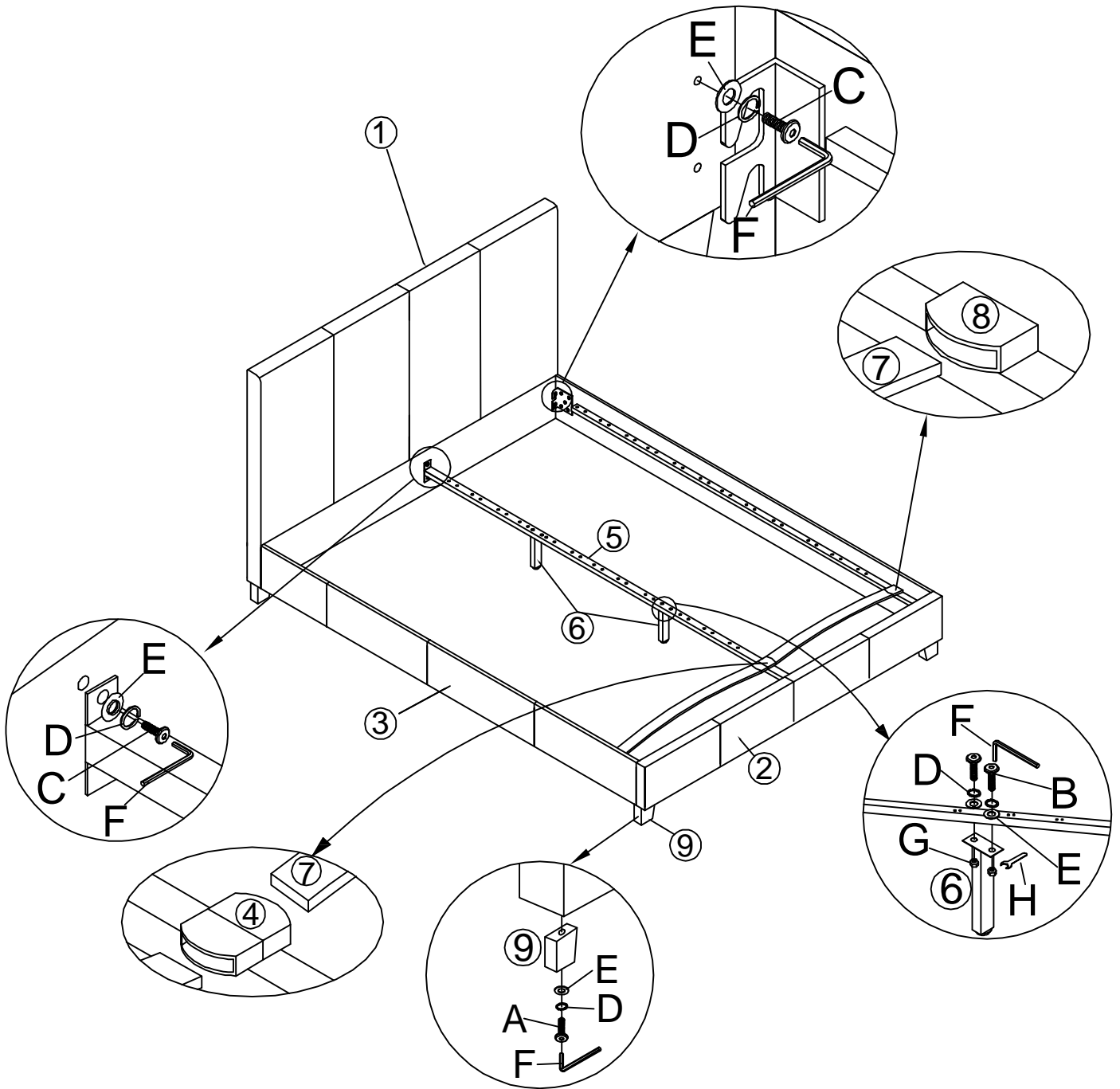

- STEP 1 :FIXING LEGS TO HEADBOARD AND FOOTBOARD;  
 STEP 2 :FIXING SUPPORT LEGS TO CENTR SUPPORT BAR;  
 STEP 3 :FIXING SIDE RAILS AND CENTRE SUPPORT BAR TO HEADBOARD AND FOOTBOARD;  
 STEP 4 :ONCE SLAT ASSEMBLED POSITION PEGS ON THE BASE OF CAPS INTO CORRESPONDING HOLES ON THE SIDE RAILS AND CENTRAL SUPPORT BAR,THEN CAREFULLY PRESS DOMN ON CAPS TO SECURE.