

# ASSEMBLY DIAGRAM

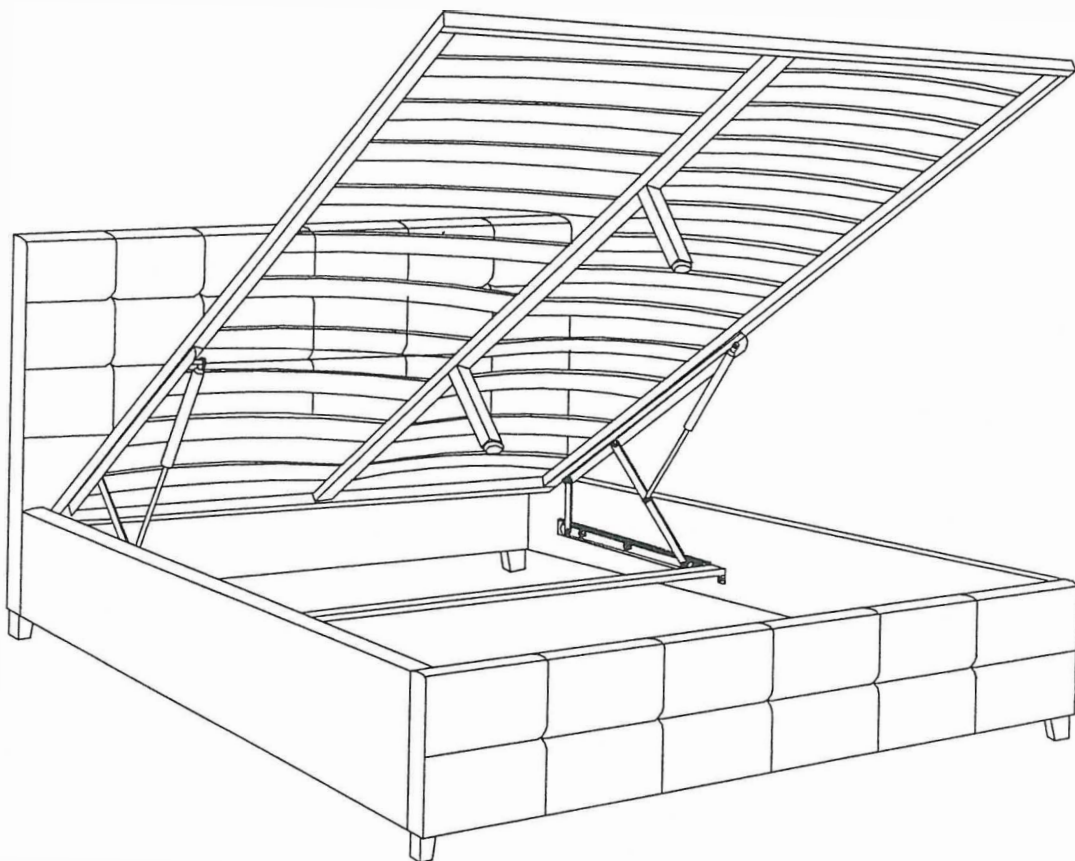





IMPORTANT NOTE:

- ※ PLACE ALL PARTS ON A CLEAN AND SMOOTH SURFACE SUCH AS A RUG OR CARPET TO AVOID THE PARTS FROM BEING SCRATCHED.
- ※ KINDLY FOLLOW THE ASSEMBLY INSTRUCTIONS STEP BY STEP.
- ※ DO NOT TIGHTEN ALL SCREWS UNTIL THE BED IS FULLY SET-UP.

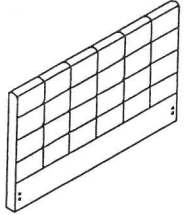
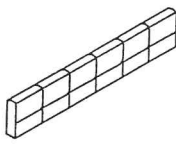
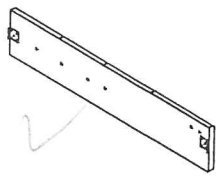
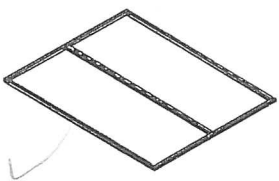



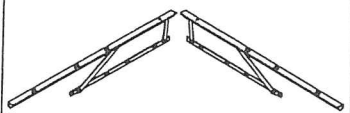

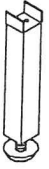
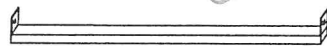
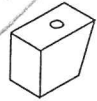
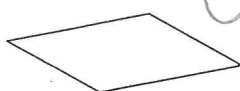
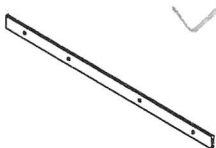



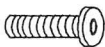





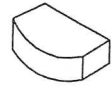
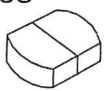

0006-00003

## Parts List

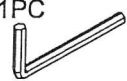
<b>A: HEAD BOARD 1PC</b> 	<b>B: FOOT BOARD 1PC</b> 	<b>C: SIDE RAIL 2PCS</b> 	<b>D: BEDSTEAD KD 1SETS</b> 
<b>E: SLAT 26PCS</b> 	<b>F: ANGLE IRON 2PCS</b> 	<b>G: STEAM MOVING BAR 2PCS</b> 	<b>H: STEAM MOVING MECHANICA 2PCS</b> 
<b>I: SQUARE TUBE 1PC</b> 	<b>J: LEG 2PCS</b> 	<b>K : 1PC</b> 	<b>L : LEG 4PCS</b> 
<b>M : Non-Moven Bed Base 1PC</b> 	<b>N : 2PCS</b> 		

## Hardware List

<b>1: BOLT 20PCS</b>  M8X45mm	<b>2: BOLT 8PCS</b>  M8X30mm	<b>3: BOLT 10PCS</b>  M6X40mm	<b>4: BOLT 10PCS</b>  M6X20mm	<b>5: ALLEN KEY 1PC</b>  M8	<b>6: NUT 14PCS</b> 
<b>7: FLAT WASHER 28PCS</b>  M8	<b>8: SPRING WASHER 28PCS</b>  M8	<b>9: ALLEN KEY 1PC</b>  M8	<b>10: SPANNER 1PC</b> 	<b>11: SLAT CAP 26PCS</b> 	<b>12: DOUBLE PLASTIC CAP 13PCS</b> 
<b>13: ANGLE IRON 2PCS</b> 	<b>14: ALLEN KEY 1PC</b>  M6	<b>15: FLAT WASHER 20PCS</b>  M6	<b>16: SPRING WASHER 20PCS</b>  M6	<b>17 1PC</b> 	

### STEP 1

1  4PCS

2  8PCS

7  12PCS

8  12PCS

9  1PC

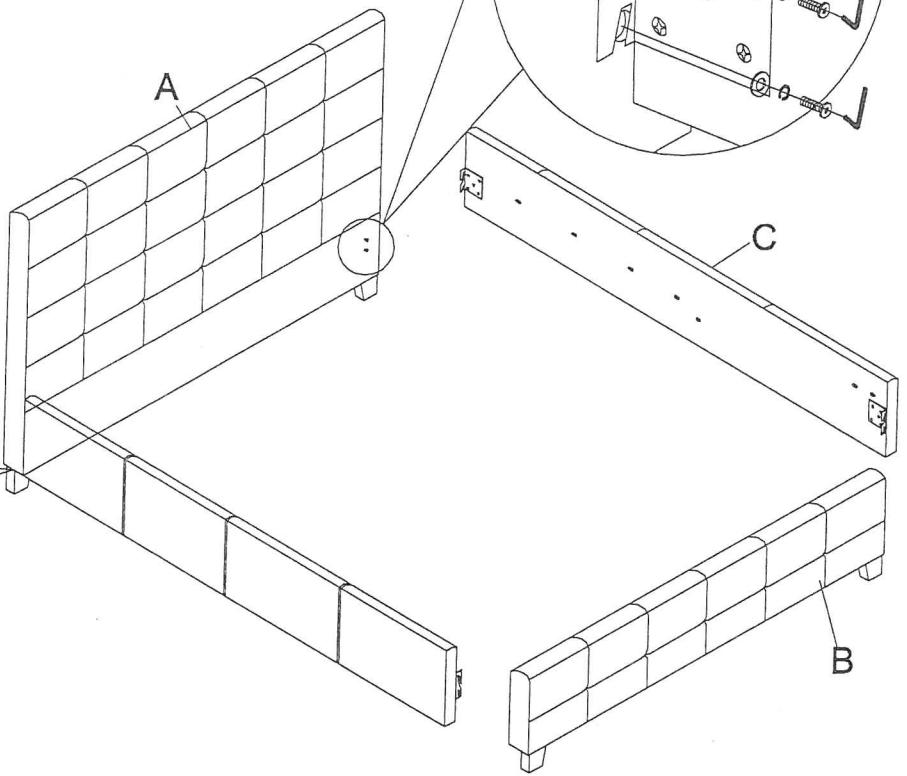
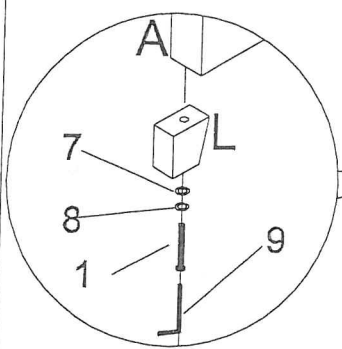

### STEP 2

3  10PCS

4  10PCS

15  20PCS

16  20PCS

F  2PCS

14  1PC

I  1PC

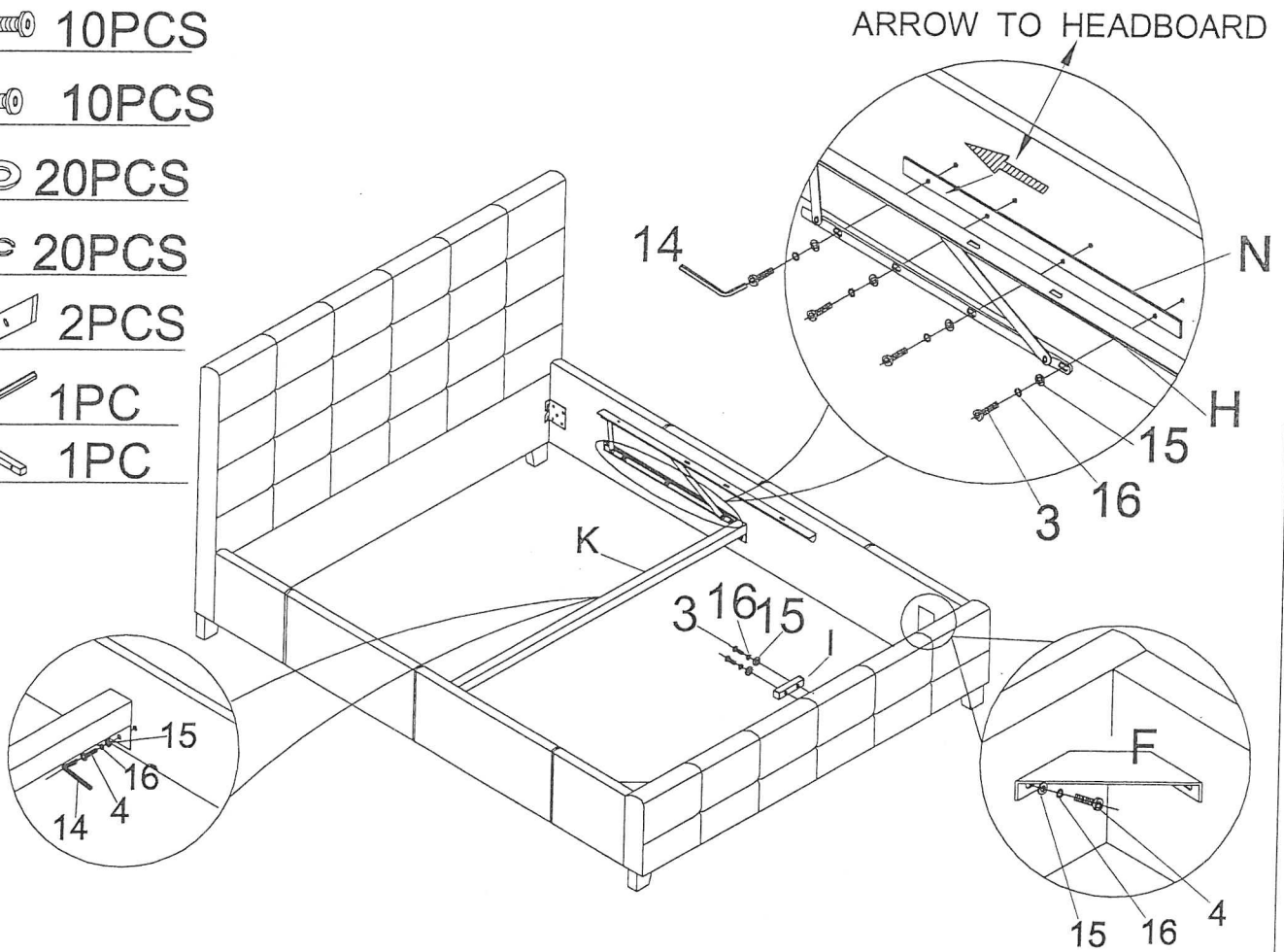

### STEP 3

1  10PCS

7  10PCS

8  10PCS

6  10PCS

9  1PC

10  1PC

13  2PCS

17  1PCS

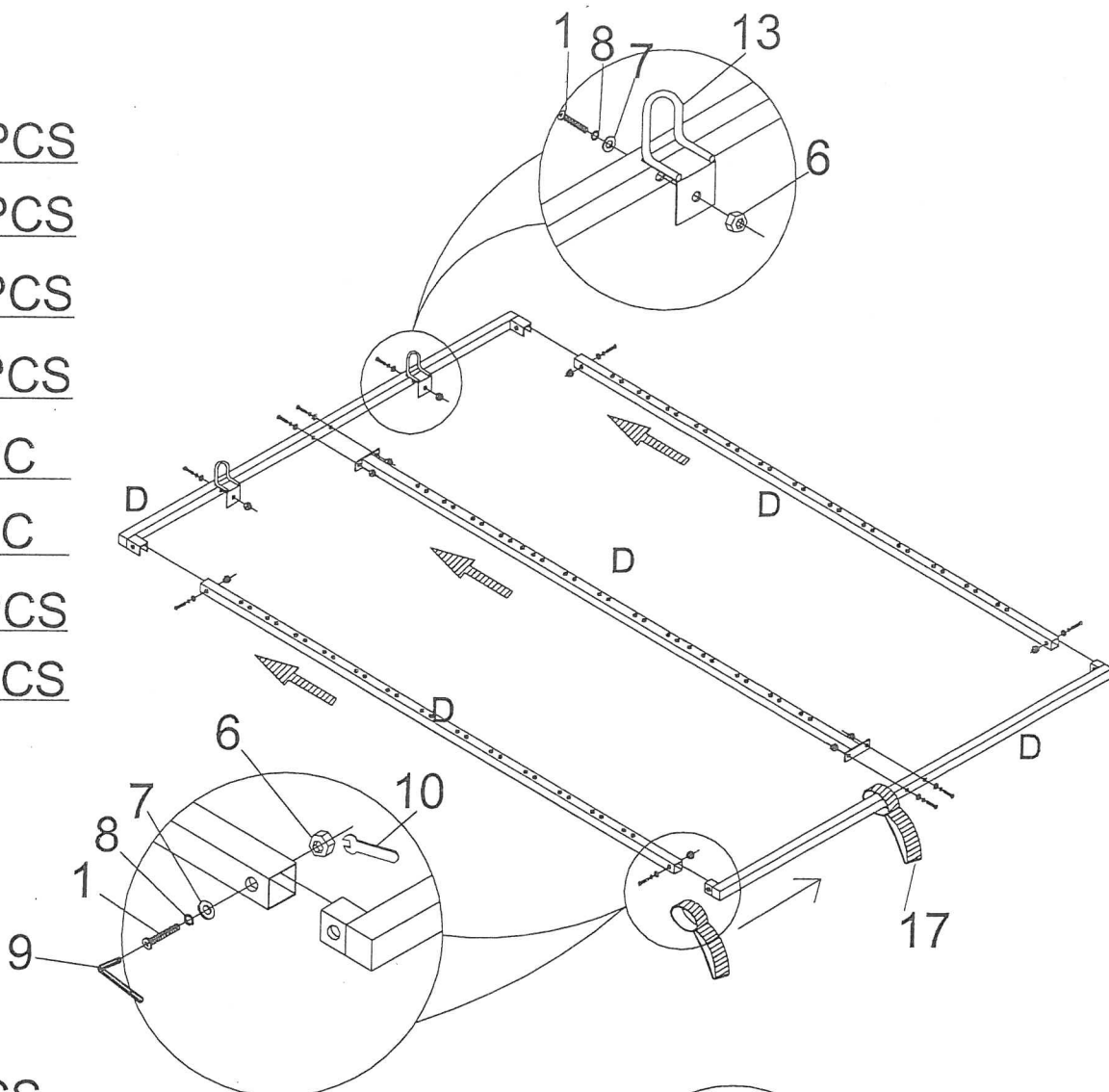

### STEP 4

1  6PCS

7  6PCS

8  6PCS

6  4PCS

9  1PC

10  1PC

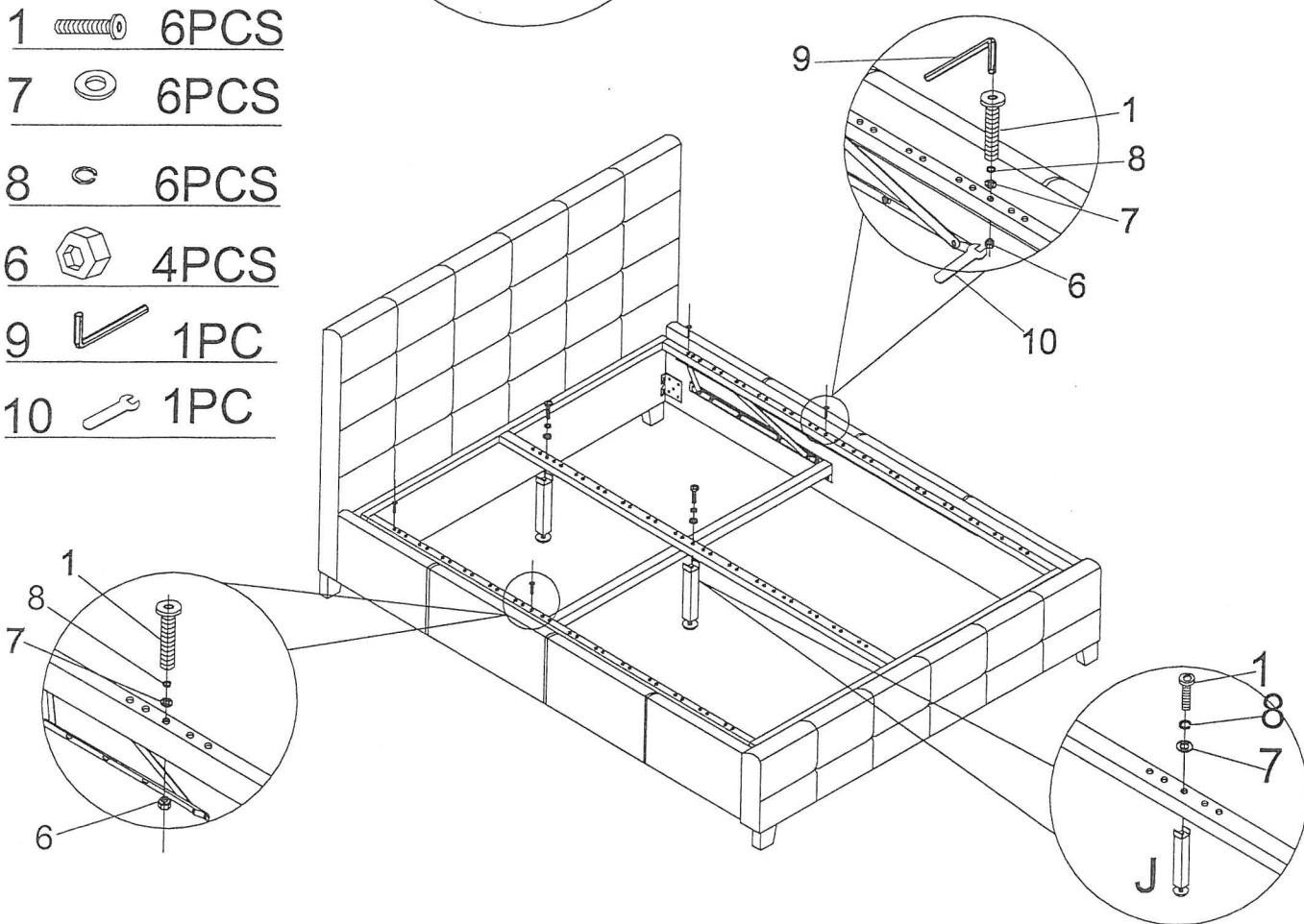

## STEP 5

11  26PCS

12  13PCS

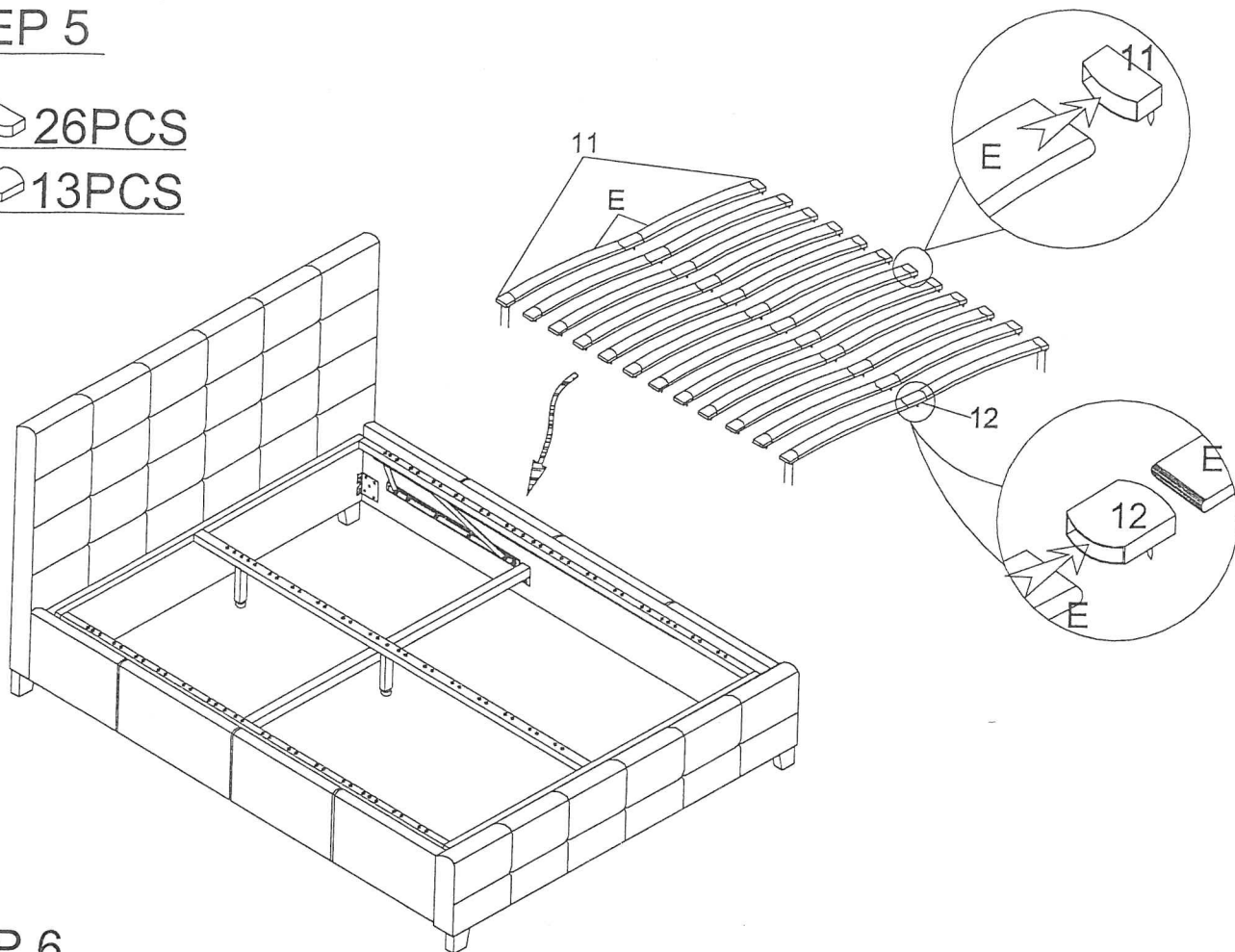

## STEP 6

5  1PC

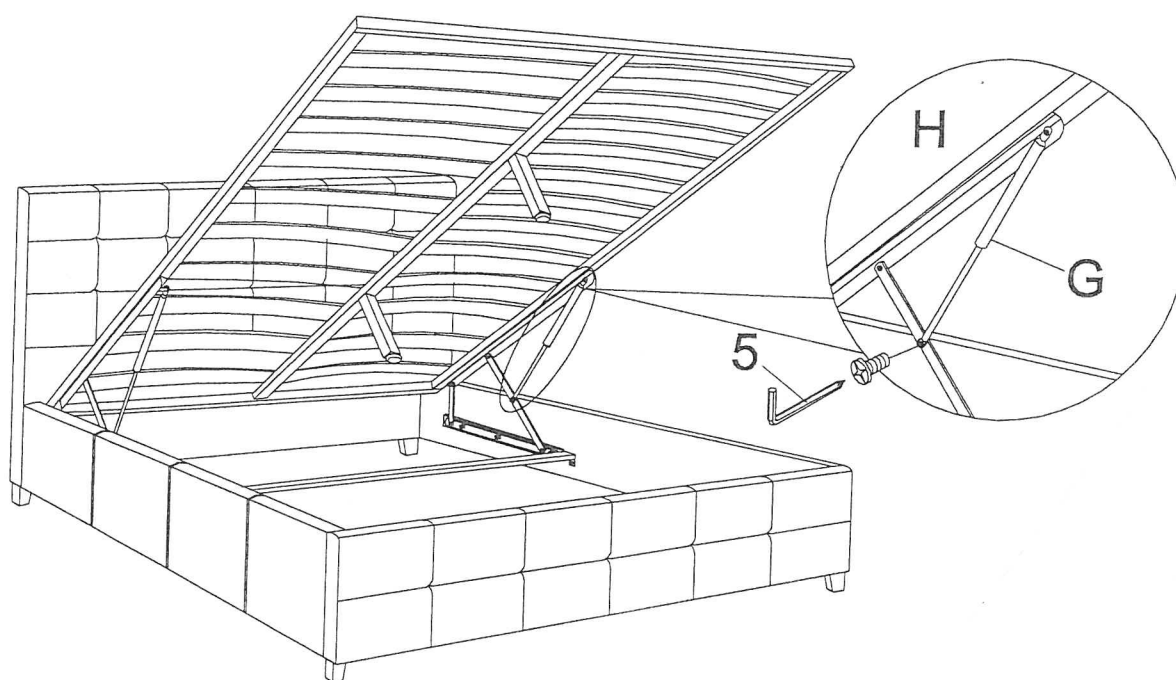

STEP 7

M  1PC

