

ASSEMBLY INSTRUCTION

MODEL : HM 353.02

DESCRIPTION : 4 DOOR WORDROBE

SOFT, DRY CLOTH	CHEMICAL	HEAT	KEEP DRY	HANDLE WITH CARE	DO NOT USE KNIFE	

HARDWARE		PART LIST	
A	WOOD DONEL 8 X 25	38	
B	16MM CB SCREW M4X30MM	68	
C	38MM CB SCREW M4X30MM	16	
D	50MM CSR CAP M4X30MM	4	
E	NAIL 5R	80	
F	L KEY	1	
G	MINIFIX CAP	39	
H	MINIFIX (PHOLISING)	35	SETS
H1	MINIFIX (EURO 24)	8	
H2	MINIFIX (EURO 24)	8	
I	HANDLE AW1 110X96 (METAL)	8	
I1	HANDLE AW1 110X96 (METAL)	8	
I2	HANDLE SCREW MAX30MM	8	
I3	HANDLE SCREW MAX30MM	8	
J	V BRACKET	2	
K	K1 K2 DRAWER SLIDE 16"	2	SETS
L	CHROME PIPE 971MM	1	
M	METAL SHIPBOARD SUPPORT	16	
N	HINGES 5R	10	

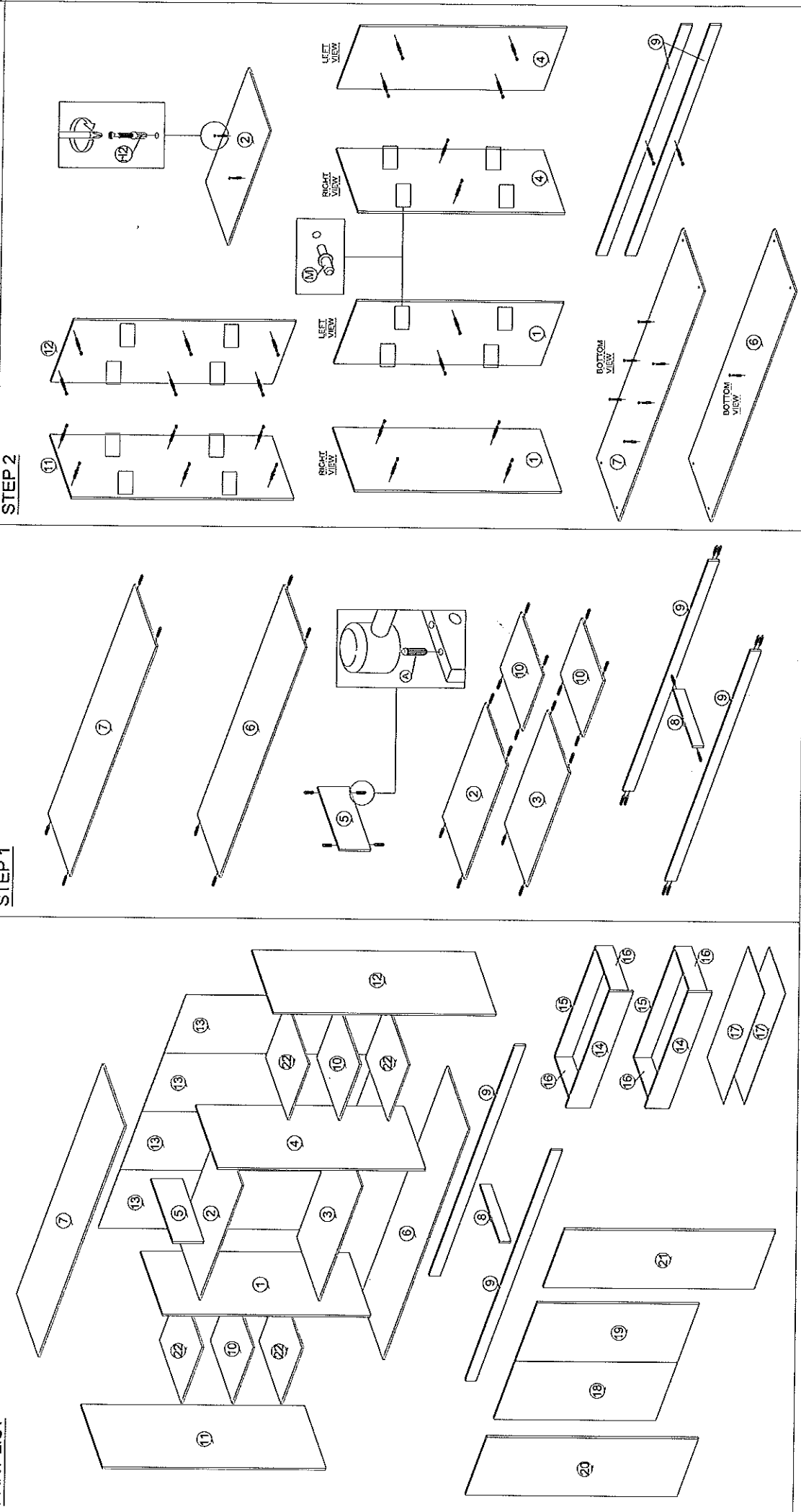

ASSEMBLY INSTRUCTION

DESCRIPTION : 4 DOOR WORDROBE

MODEL : HM 353.02

		SOFT, DRY CLOTH
		CHEMICAL
		HEAT
		KEEP DRY
		HANDLE WITH CARE
		DO NOT USE KNIFE

STEP 3

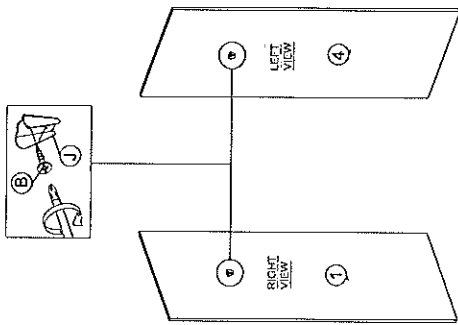

STEP 4

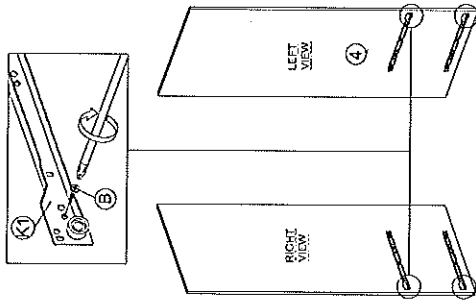

STEP 5

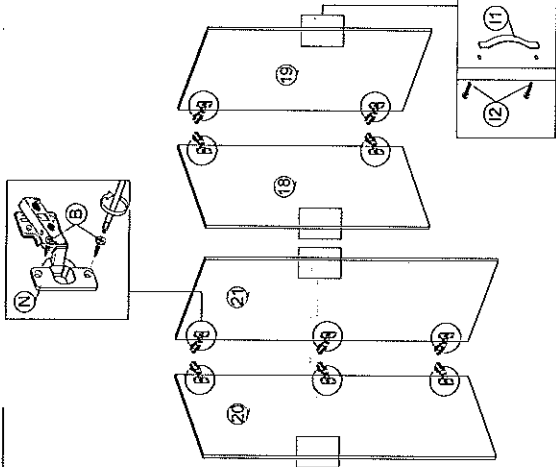

STEP 6

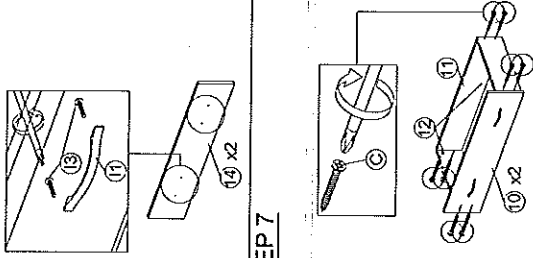

STEP 8

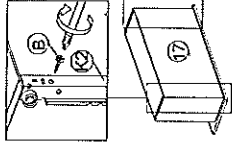

STEP 9

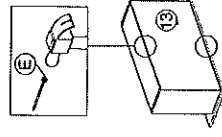

STEP 7

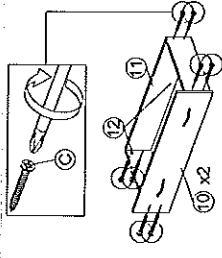

STEP 10

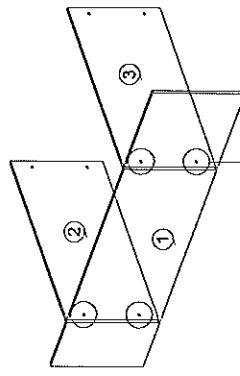

STEP 12

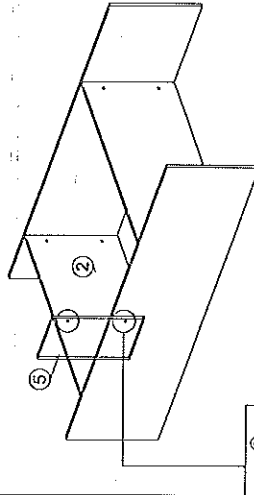

STEP 14

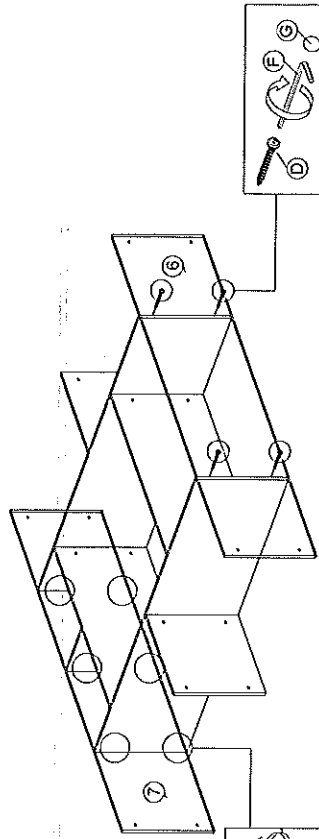

STEP 11

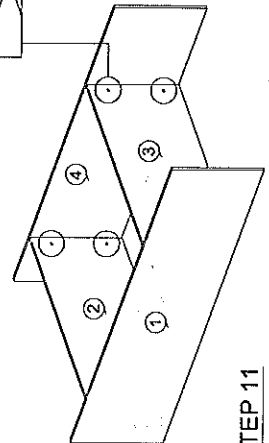

STEP 13

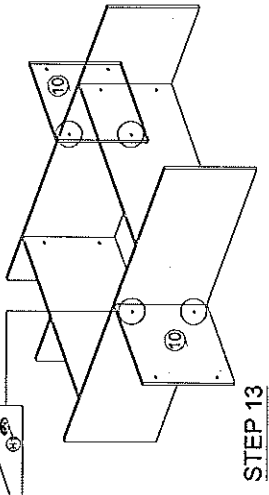

STEP 15

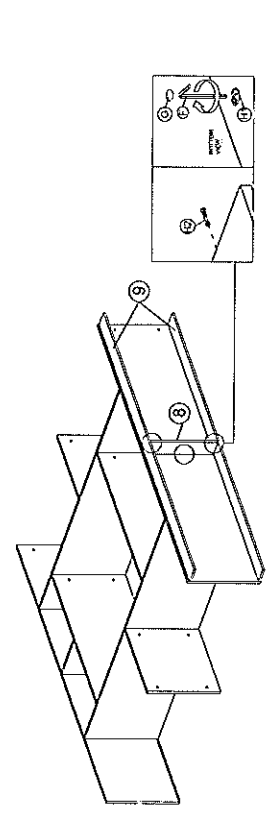

ASSEMBLY INSTRUCTION

DESCRIPTION : 4 DOOR WORDROBE

MODEL : HM 353.02

SOFT, DRY CLOTH	CHEMICAL	HEAT	KEEP DRY	HANDLE WITH CARE	DO NOT USE KNIFE		

STEP 16

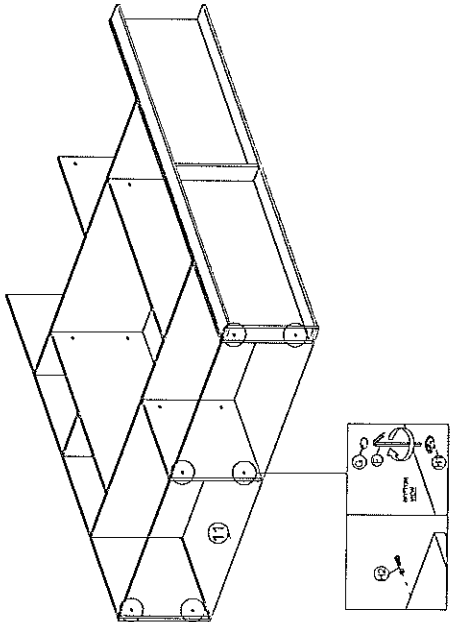

STEP 17

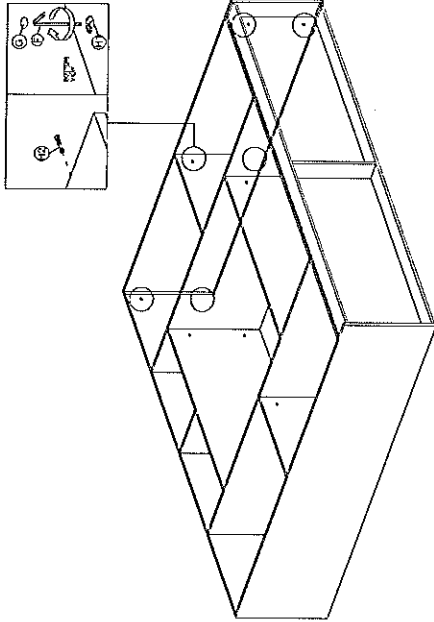

STEP 18

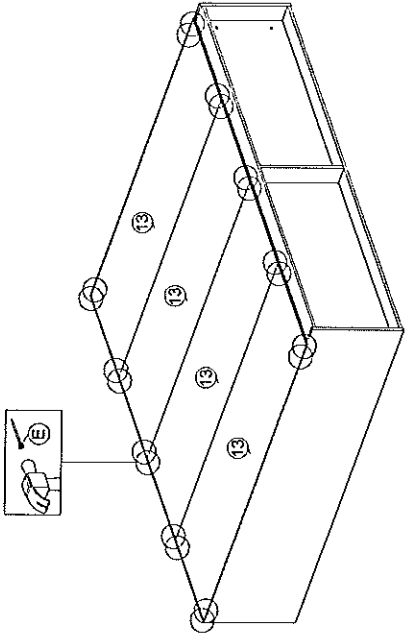

STEP 19

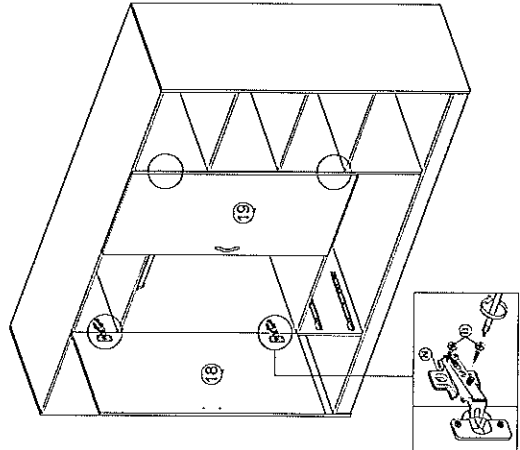

STEP 20

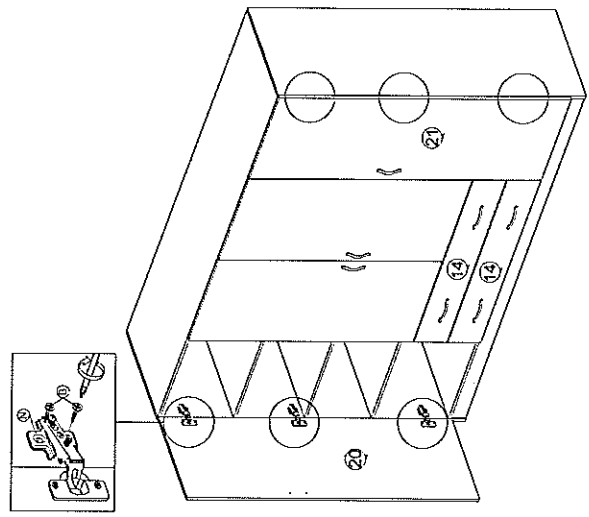

COMPLETED

